

eka SYSTEM | complex cosmos D

Doppelwandige Edelstahl-Abgasanlage
Designlösung ohne Klemmband
Isolierdicke 25 mm Ø 130 - 300 mm

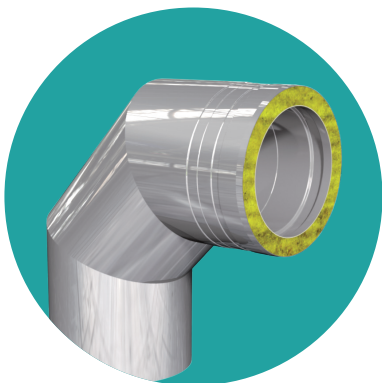

PREISLISTE 2025
TECHNISCHE DATEN

STAND NOV. 2024



eka

A Sphering Company

EINE GUTE PARTNERSCHAFT VON ANFANG AN

eka zählt zu den führenden Herstellern von Edelstahlkaminen, Abgas- und Lüftungssystemen in Deutschland.

Mit unserem Know how und fast 40 Jahren Erfahrung in der Entwicklung und Herstellung innovativer Abgas-, Lüftungs- und Schornsteinsysteme aus Edelstahl sind wir der richtige Partner für Ihr Projekt.

WILLKOMMEN BEI EINEM DER FÜHRENDEN HERSTELLER IN EUROPA

Unsere Anlagen sind europaweit bekannt für Innovation und höchste Qualität. Seit 2023 sind wir Teil der Sphering Group, einem der europäischen Marktführer in der Entwicklung, Herstellung und dem Vertrieb fortschrittlicher Luft- und Abgassysteme.

Unser Ansatz im Umgang mit Kunden ist partnerschaftlich. Wir verstehen uns nicht nur als Lieferant, sondern als verlässlicher Partner auf Ihrem Weg zu einer erfolgreichen Lösung. Als anerkannter Problemlöser haben wir uns in den vergangenen Jahrzehnten einen Ruf erarbeitet, der auf Qualität, Expertise und Zuverlässigkeit beruht. Wir sind stolz darauf, dass wir Sie sowohl technisch, als auch fachlich umfassend kompetent beraten können.



INDIVIDUELLE LÖSUNGEN? SONDERANFERTIGUNGEN SIND UNSERE SPEZIALITÄT

Unsere langjährige Erfahrung ermöglicht es uns, Anlagen zu konstruieren und herzustellen, die exakt auf Ihre spezifischen Anforderungen und baulichen Gegebenheiten abgestimmt sind. Jede bauliche Situation ist einzigartig - hierfür entwickeln wir maßgeschneiderte Lösungen, die Ihre Erwartungen erfüllen und übertreffen.

Unser Ziel ist es, nicht nur ein Produkt zu verkaufen, sondern Ihnen eine nachhaltige Lösung anzubieten, die langfristigen Mehrwert bringt. Wir begleiten Sie von der Planungsphase bis hin zur Fertigstellung.

Lassen Sie uns gemeinsam an Ihrer Vision arbeiten und die optimale Anlage für Ihre baulichen Gegebenheiten umsetzen.



ALLES AUS EINER HAND

eka KUNDENSERVICE

Der gesamte Planungs- und Fertigungsprozess, vom Projektmanagement über die Projektentwicklung, einer umfassenden Planung und Kalkulation, über CAD-Konstruktion bis hin zur termingerechten Produktion der Anlage mit hochmoderner Fertigungstechnologie liegt in einer Hand.

eka fertigt effiziente Anlagen, auf die Sie sich verlassen können.



PRODUKTE IN HÖCHSTER QUALITÄT SCHNELL UMGESETZT

Mit unserem vielseitigen Angebot decken wir alle Anwendungen im privaten, gewerblichen und industriellen Bereich ab.

Bei der Herstellung unserer Edelstahlkamine und Schornsteinsysteme legen wir großen Wert auf Qualität, Sicherheit und Langlebigkeit. Alle unsere Produkte werden sorgfältig geprüft und entsprechen den geltenden Vorschriften und Normen. Mit unserem hochmodernen Maschinenpark können wir sowohl Serienteile, als auch Sonderteile mit der gleichen Sorgfalt, Qualität und Geschwindigkeit herstellen.

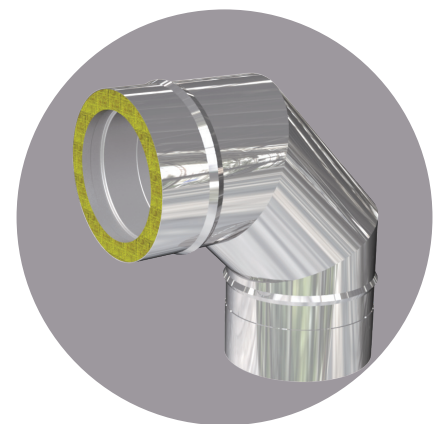

ÜBER UNS

Sphering ist eines der führenden Industrieunternehmen für Abgas- und Schornsteinsysteme in Europa.

Mit mehr als 1.000 erfahrenen Mitarbeitern in ganz Europa ist Sphering einer der europäischen Marktführer mit anerkanntem Fachwissen in der Entwicklung, Herstellung und dem Vertrieb von fortschrittlichen Luft- und Abgassystemen.

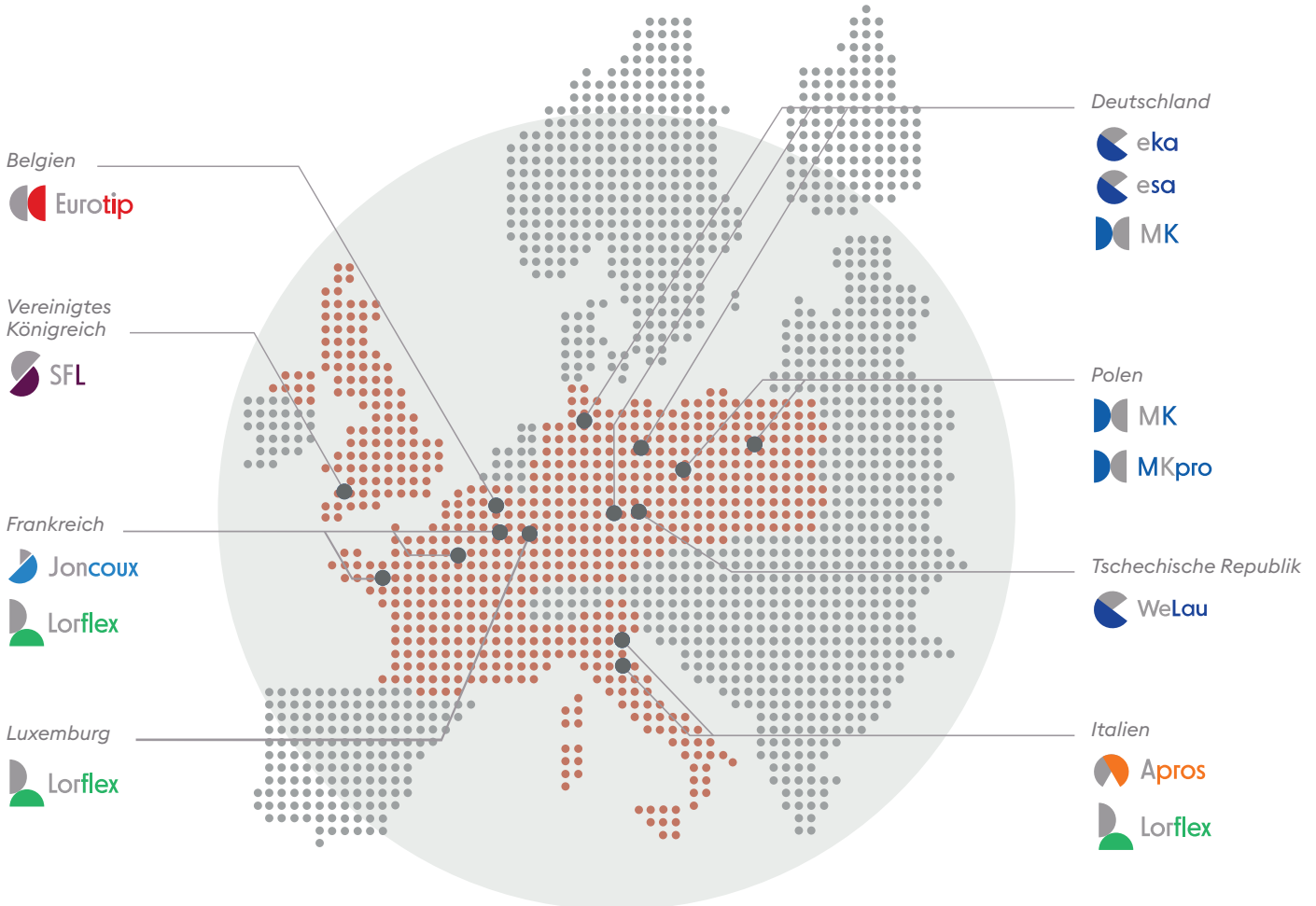

+1000
Mitarbeiter



8
Produktionsstätten



26
Vertriebsniederlassungen

EINE EINZIGARTIGE KOMBINATION AUS LOKALEM ANSATZ UND GLOBALER EFFIZIENZ

WIR WOLLEN GUTES TUN, INDEM WIR GUTES TUN

Mit Kunden

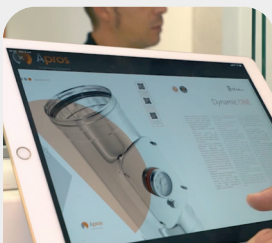

Mit Mitarbeitern

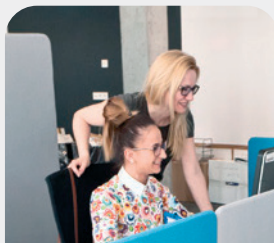

Mit sicheren und effizienten Produkten

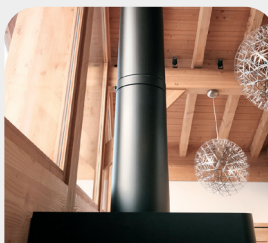

Mit Umwelt und Gesellschaft



UNSERE WERTE

Das Unternehmen ist seinen historischen Werten treu geblieben und arbeitet mit einem exklusiven Industriemodell, das auf der Autonomie seiner Marken beruht. Sphering entwickelte sich in einem Jahrhundert, zu einer ethischen industriellen Unternehmensgruppe in Europa.

Since 1919
100 YEARS
of passion



Zuverlässiger Partner



Spitzenprodukte



Familienorientierte Weitsicht



**No Shortcut
Keine Kompromisse
bei Innovation, Sicherheit
und Qualität**

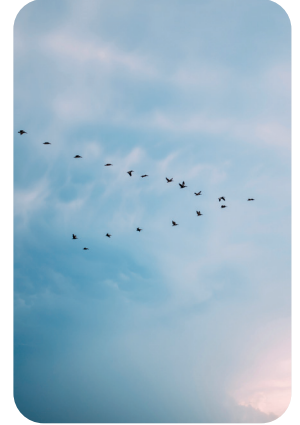

Lokaler Ansatz



UNSERE R&D UND INNOVATIONS-CENTER

Wir sind hier, um zu bleiben und gemeinsam aktivieren wir unsere Kapazitäten, um den Anforderungen unserer Branche gerecht zu werden.

MEHR ALS 150 TESTS JEDES JAHR

Diese Tests beruhen auf Anforderungen, die wir aufgestellt haben, um unseren Kunden ein Höchstmaß an Sicherheit und Leistung zu garantieren.



Thermisch



Mechanisch



**Stabilität/
Widerstands-
fähigkeit**



Feinstaub

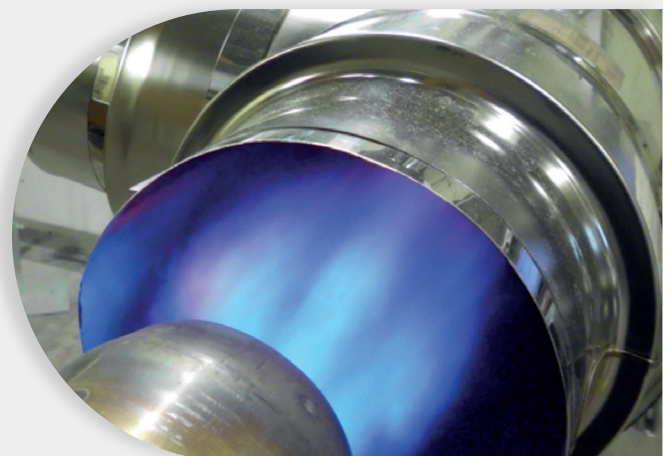

ENTWICKLUNG UND TESTS FÜR HERSTELLER

Um fortschrittliche Sicherheit, Leistung, Qualität und Innovation zu gewährleisten.

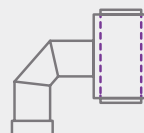

**Individuelle Komponenten
Co-Entwicklung**



**Kombinationstest
Zertifizierung**

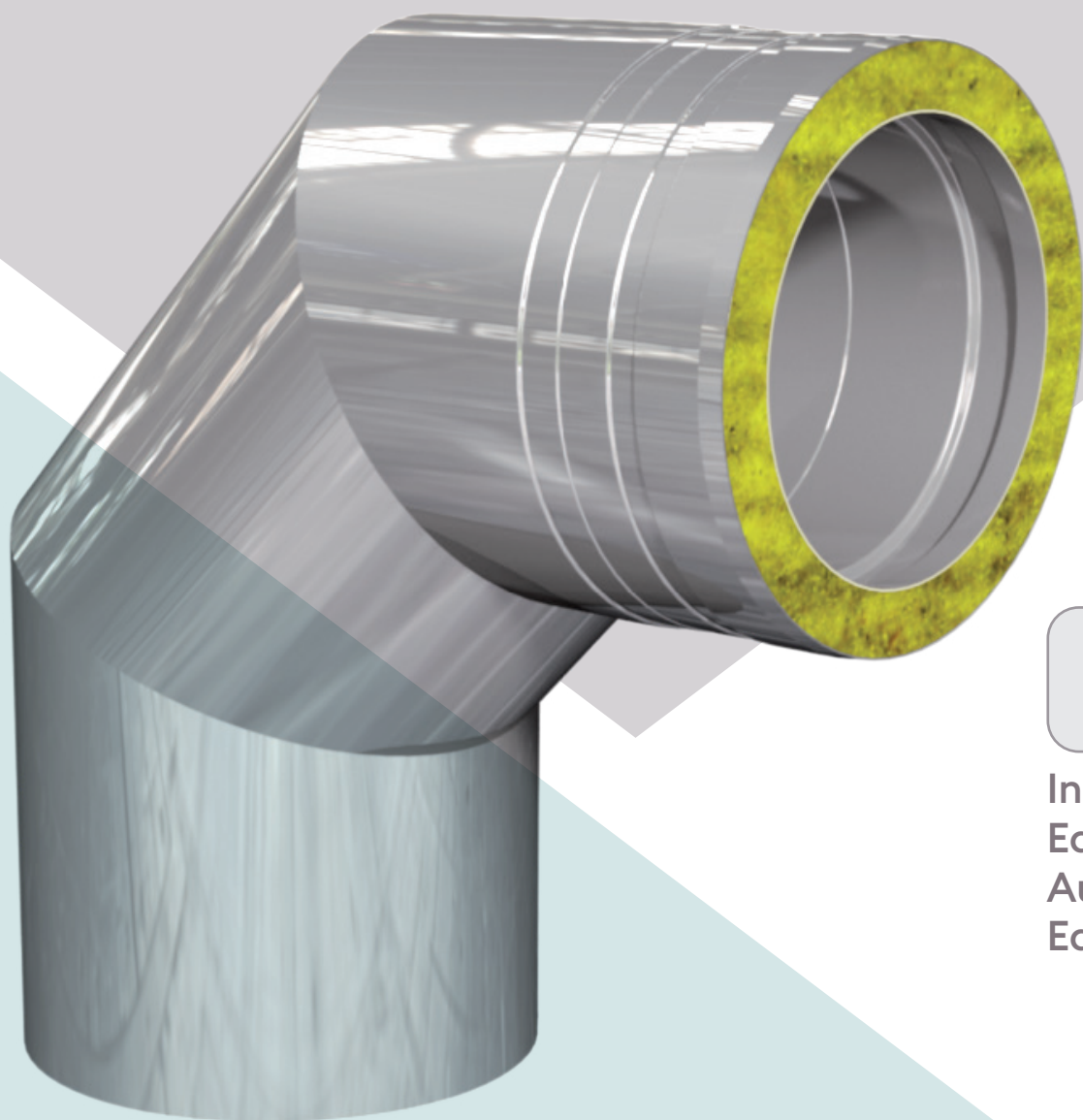

Innenrohr:
Edelstahl 1.4404
Außenrohr:
Edelstahl 1.4301



eka complex cosmos D

Doppelwandige Edelstahl-Abgasanlage

Designlösung ohne Klemmband

Isolierdicke 25 mm Ø 130 - 300 mm

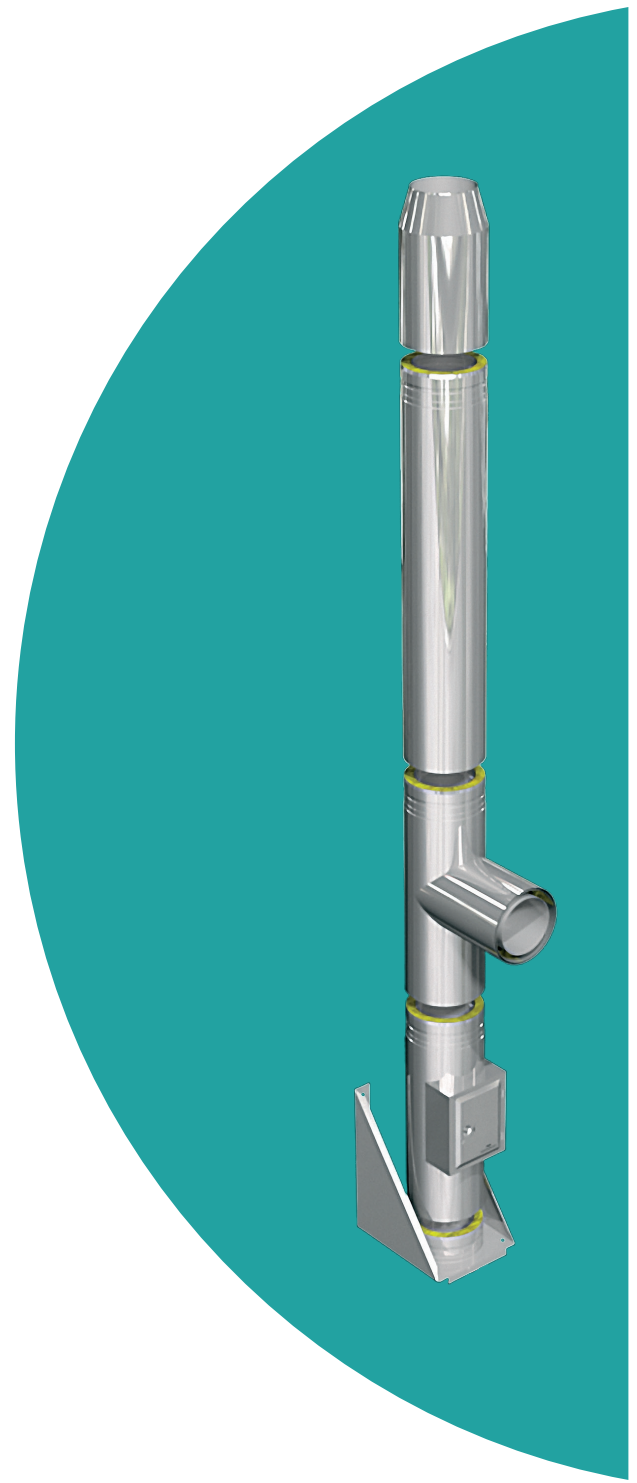

eka

A Sphering Company

TECHNISCHE DATEN SYSTEM eka COMPLEX COSMOS D DOPPELWANDIG / DOUBLE WALLED

Materialart:

Innenrohr
Außenrohr
Einstecktiefe

Edelstahl, 1.4404 bzw. 1.4571, AISI 316L
Edelstahl, 1.4301, AISI 304
80 mm

Materialstärke:

Innenrohr
Außenrohr

0,6 mm
0,6 mm

Brennstoffe:

Max. Dauer- Abgastemperatur:

Betriebsweise:

Öl, Gas, Festbrennstoff
600°C
Unterdruck, Überdruck

Dicke Wärmedämmung:

25 mm Mineralfaserdämmschalen (KI 40) (2250)

CE - Zertifizierung/Leistungserklärung:

001 DOP 90216 2013

EN 1856-1 T400 N1 W V2 L50045 050
EN 1856-1 T600 N1 W V2 L50045 G75
EN 1856-1 T600 N1 D V3 L50055 G75
EN 1856-1 T200 P1 W V2 L50045 000
EN 1856-1 T200 H1 W V2 L50045 000



Ausführung Außenschale glänzend/matt:

Ausführung Außenschale gebürstet:

Außenschale pulverbeschichtet in RAL-Farbe

Art.-System-Nr.: 2200/1200
10% Aufpreis
auf Wunsch gegen Aufpreis

Ø in mm	130	150	160	180	200	250	300
Fläche/area in cm ²	133	177	201	255	314	491	707
Gewicht / weight in kg/m 25 mm Isolierung / isolation	6,7	7,7	8,2	9	9,9	12,6	14,1

material type:

interior pipe
outside pipe
depth of the connecting sleeves

stainless steel, 1.4404 or 1.4571, AISI 316L
stainless steel, 1.4301, AISI 304
80 mm

material thickness:

interior pipe
outside pipe

0,6 mm
0,6 mm

fuel type:

maximal sustained exhaust temperature:
operating modes:

oil, natural gas, solid fuel
600°C
negative pressure, positive pressure

thickness of isolation:

25 mm mineral-fibre isolation (KI 40) (2250)

CE - certification/declaration of performance:

001 DOP 90216 2013

EN 1856-1 T400 N1 W V2 L50045 050
EN 1856-1 T600 N1 W V2 L50045 G75
EN 1856-1 T600 N1 D V3 L50055 G75
EN 1856-1 T200 P1 W V2 L50045 000
EN 1856-1 T200 H1 W V2 L50045 000

execution outside pipe shining/matt:

execution outside pipe brushed

execution outside powder-coated in RAL colour

Art.-system-n.: 2200/1200
10 % surcharge
on request for an additional charge





SYSTEMAUFBAU



Das System eka complex cosmos D ist ein universelles dreischaliges (isoliertes) System zur Ableitung von Abgasen aus Wärmezeugern. Als elegante Designlösung wird es ohne Klemmbänder montiert. Das feuchteunempfindliche System ist rußbrandbeständig. Es kann am Gebäude oder innen angebaut werden. Beim Anbau am Gebäude sind die Brand-schutzanforderungen zu beachten.

Auf das Fundament oder das entsprechende Sockel-element oder die verstellbare Wandkonsole wird die Bodenplatte mit Kondensatablauf geschraubt. Darüber wird die Prüföffnung gesteckt. Aus den bau-lischen Gegebenheiten, Anschlußhöhe der Verbin-dungsleitung und Höhe des Schornsteinfußes, ergibt sich, ob auf die Prüföffnung direkt der Feuerungs-an-schluß gesteckt wird oder ob ein Längenelement (L10, L5, L3) als Zwischenstück Verwendung findet. Jede Steckverbindung ist mechanisch zu verfestigen. Als Paßlängen können das kürzbare Längenelement 1080 mm (L10ET) oder 540 (L5ET) verwendet werden.

Über dem Feuerungsanschluß werden die entspre-chend der Schornsteinhöhe erforderlichen Längen-elemente montiert. Auf das letzte Längenelement ist ein Mündungsabschluß (M) oder eine Regenhaube (RH) aufzustecken. Mindestens alle 4 m ist die Ab-gasanlagen mittels Wandhalter zu befestigen. Die freie Auskragung oberhalb der letzten Befestigung darf 3 m nicht überschreiten. Hier sind ab der letz-ten Steckverbindung unterhalb der obersten Befestigung die speziellen statischen Bauteile zu ver-wenden. Andernfalls sind Seilabspannungen oder ein Krugarm erforderlich.

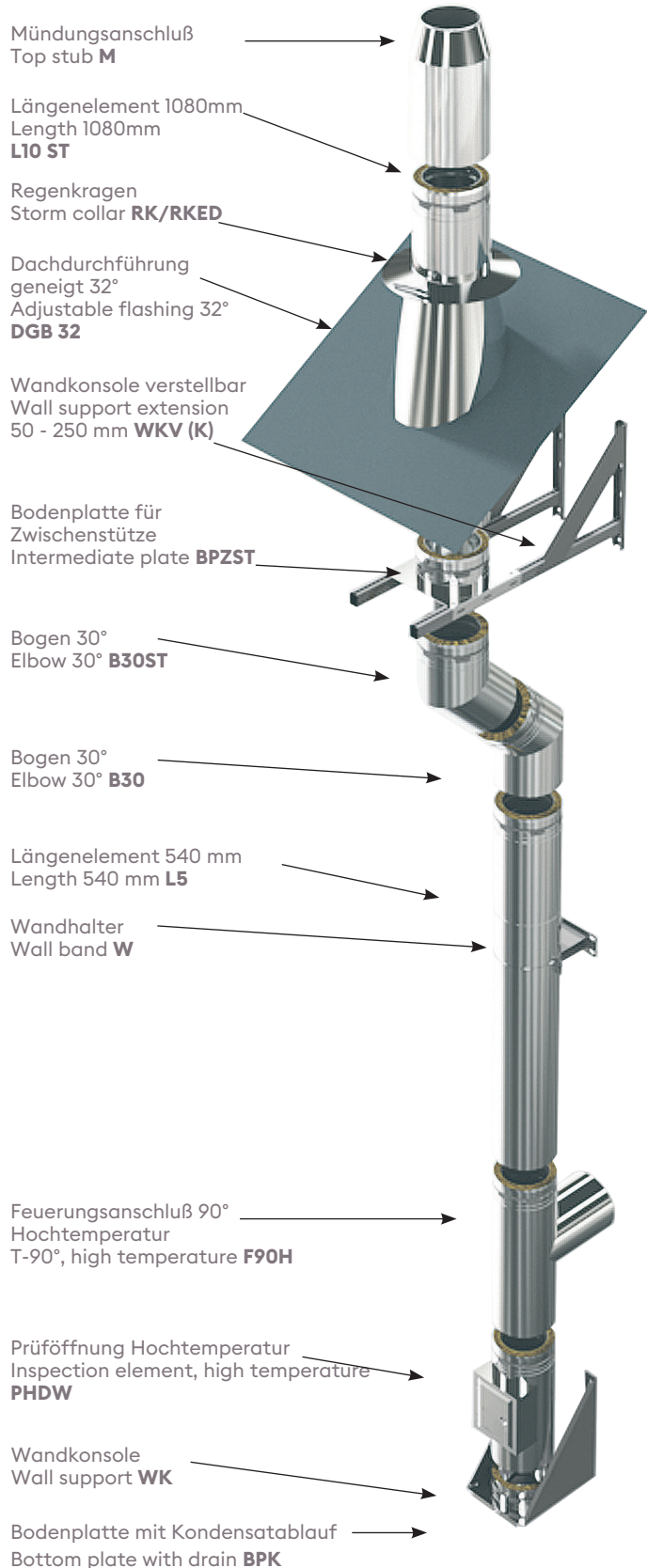

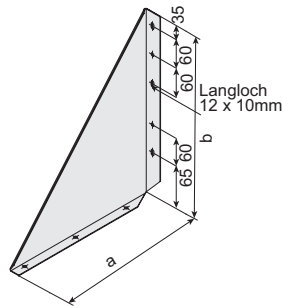

Wandkonsole 50 mm

2200-Ø-WK



Ø d	a	b	*Lg	€
130	260	375	-	73,40
150	280	385	-	76,50
160	310	400	-	86,00
180	310	400	-	86,00
200	330	430	-	96,30
250	380	480	-	124,70
300	430	535	-	137,20



-  Wall support
-  Support mural

Wandkonsole verstellbar 50 - 90 mm

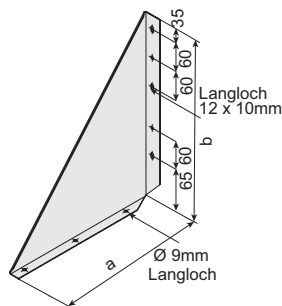
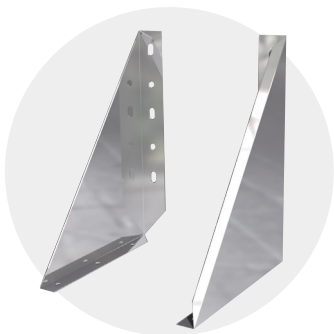
2200-Ø-WKV5



Ø d	a	b	*Lg	€
130	300	375	-	109,90
150	320	385	-	114,70
160	340	400	-	124,20
180	350	400	-	128,90
200	370	430	-	144,40
250	420	480	-	186,80
300	470	535	-	205,60



-  Wall support adjustable 50 - 90 mm
-  Support mural réglable 50 - 90 mm

Wandkonsole verstärkt, verstellbar 50 - 150 mm

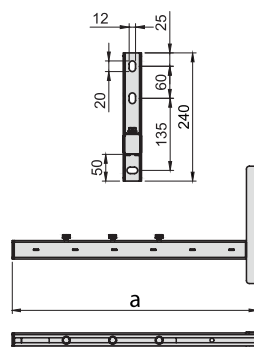
2200-Ø-WKV-15



Ø d	a	*Lg	€
130	380	-	130,80
150	380	-	130,80
160	480	-	156,80
180	480	-	156,80
200	480	-	156,80
250	480	-	156,80

-  Wall support adjustable 50 - 150 mm
-  Support mural réglable 50 - 150 mm

 **HINWEIS**

Aufbauhöhe:
NW 80 bis 150 max. 20 m
NW 160 bis 250 max. 15 m

Wandkonsole, verstellbar 50 - 250 mm

2200-Ø-WKV(K)

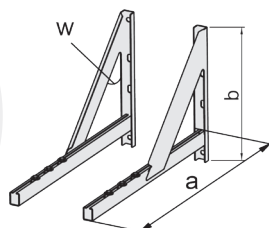

Ø d	a	b	W	*Lg	€
130	550	400	34°	-	193,00
150	550	400	34°	-	193,00
160	550	400	34°	-	193,00
180	550	400	34°	-	193,00
200	550	400	34°	-	193,00
250	650	400	34°	-	208,90
300	650	400	34°	-	208,90

-  Wall support adjustable 50 - 250 mm
-  Support mural réglable 50 - 250 mm

 **HINWEIS**

Achtung: Bei Montage der Konsolen mit Schenkel nach unten, wird zur Montage der Bodenplatten ein Satz Wandkonsolenadapter WKA benötigt.

*Lg=Legierungsgewicht: Lg (in kg) x Faktor Legierungszuschlag (in €/kg) = Netto-Aufpreis Legierungszuschlag



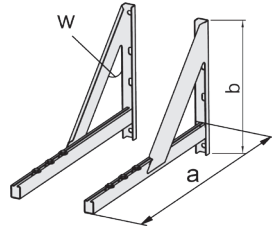

Wandkonsole, verstellbar 50 - 500 mm

2200-Ø-WKV-(L)



Ø d	a	b	W	*Lg	€
130	800	400	34°	-	226,80
150	800	400	34°	-	226,80
160	800	400	34°	-	226,80
180	800	400	34°	-	226,80
200	800	400	34°	-	226,80
250	900	500	45°	-	274,80
300	900	500	45°	-	274,80

 Wall support adjustable
50 - 500 mm

 Support mural réglable
50 - 500 mm

HINWEIS

Achtung: Bei Montage der Konsolen mit Schenkel nach unten, wird zur Montage der Bodenplatten ein Satz Wandkonsolenadapter WKA benötigt.

Wandkonsole verstärkt, verstellbar 50 - 500 mm

2200-Ø-WKV-LV

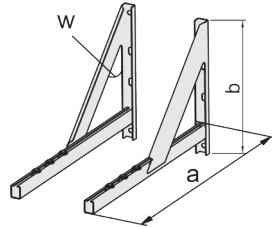

Ø d	a	b	W	*Lg	€
130	800	400	60°	-	408,30
150	800	400	60°	-	408,30
160	800	400	60°	-	408,30
180	800	400	60°	-	408,30
200	800	400	60°	-	408,30
250	900	500	60°	-	494,60
300	900	500	60°	-	494,60

 Reinforced wall support,
adjustable 50 - 500 mm

 Support mural renforcé,
réglable 50 - 500 mm

Wandkonsolenadapter (Satz = 6 Stück)

1000-000-WKA

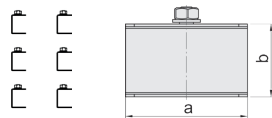
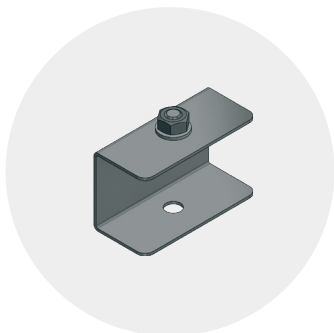

Ø d	a	b	*Lg	€
-	70	42	-	58,80

 Wall bracket adapter

 Adaptateur de support
mural

HINWEIS

Max. Aufbauhöhe über Konsole bis NW 300 mm: 5 m

Nicht geeignet für Wandkonsole WKV-LV

Bodenplatte mit Kondensatablauf, runde Sockelausführung, 1000mm

2200-Ø-BPKR

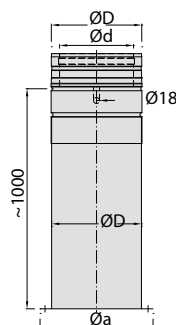

Ø d	Ø D	Ø a	*Lg	€
130	180	250	1,37	235,60
150	200	270	1,56	243,40
160	213	283	1,66	251,30
180	230	300	1,85	259,20
200	250	320	2,05	267,10
250	300	370	2,56	328,60
300	350	420	3,08	362,20

 Bottom plate with round
basic element, 1000 mm,
cuttable

 Socle rond pour conduit,
1000 mm, ajustable

*Lg=Legierungsgewicht: Lg (in kg) x Faktor Legierungszuschlag (in €/kg) = Netto-Aufpreis Legierungszuschlag

Bodenplatte mit Kondensatablauf, 500 mm, kürzbar, runde Sockelausführung

2200-Ø-BPKR5

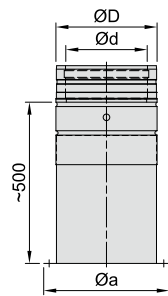

Ø d	Ø D	Ø a	*Lg	€
130	180	250	1,10	188,50
150	200	270	1,25	194,80
160	213	283	1,33	201,10
180	230	300	1,48	207,40
200	250	320	1,64	213,70
250	300	370	2,05	262,90
300	350	420	2,46	289,80

-  Bottom plate with round basic element, 500 mm, cuttable
-  Socle rond pour conduit, 500 mm, ajustable

Bodenplatte mit Kondensatablauf senkrecht und Tür, 1000 mm, kürzbar, runde Sockelausführung

2200-Ø-BPKR-ST

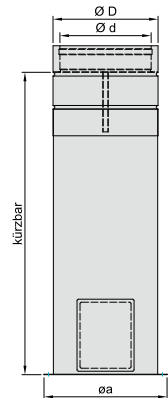

Ø d	Ø D	Ø a	*Lg	€
130	180	250	1,37	265,60
150	200	270	1,56	273,40
160	213	283	1,66	281,30
180	230	300	1,85	289,20
200	250	320	2,05	297,10
250	300	370	2,56	358,60
300	350	420	3,08	392,20



-  Bottom plate with vertical condensate drain, round basic element with door, 1000 mm, cuttable
-  Socle avec drainage de la condensation vertical, modèle de socle rond avec porte, 1000 mm, ajustable

Bodenplatte Sockelausführung (60mm Höhe) mit Kondensatablauf

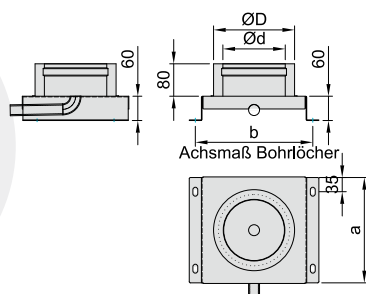
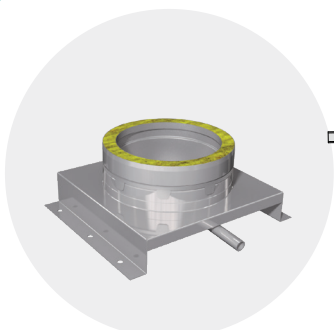
2200-Ø-BKSO



Ø d	Ø D	a	b	*Lg	€
130	180	240	270	1,69	86,00
150	200	260	290	1,91	86,00
160	213	290	320	2,27	86,00
180	230	290	320	2,27	91,50
200	250	310	340	2,53	104,20
250	300	360	420	3,23	130,90
300	350	410	470	4,00	152,70



-  Base plate with condensate drain, 60 mm high
-  Plaque de base avec drainage de la condensation, hauteur 60 mm

Bodenplatte in runder Sockelausführung mit Kondensatablauf

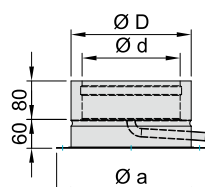
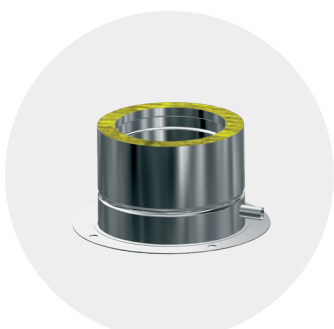
2200-Ø-BKSO-R



Ø d	Ø D	Ø a	*Lg	€
130	180	250	1,69	77,40
150	200	270	1,91	77,40
160	213	283	2,27	77,40
180	230	300	2,27	82,40
200	250	320	2,53	93,80
250	300	370	3,23	117,90
300	350	420	4,00	137,50

-  Base plate with condensate drain, 60 mm high, round
-  Plaque de base avec drainage de la condensation, hauteur 60 mm

*Lg=Legierungsgewicht: Lg (in kg) x Faktor Legierungszuschlag (in €/kg) = Netto-Aufpreis Legierungszuschlag



Bodenplatte mit Kondensatablauf

2200-Ø-BPK

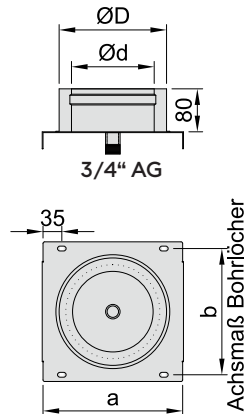
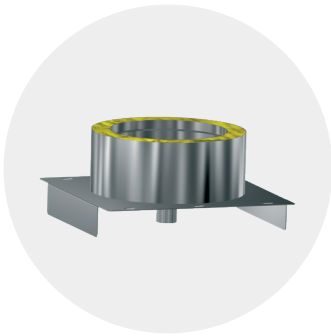

Ø d	Ø D	a	b	*Lg	€
130	180	240	215	1,39	68,60
150	200	260	235	1,61	71,10
160	213	290	265	1,92	72,70
180	230	290	265	1,97	76,50
200	250	310	285	2,22	88,30
250	300	360	335	2,91	111,90
300	350	410	385	3,68	123,20

 Base plate with condensate drain

 Plaque de base avec drainage de la condensation

Bodenplatte geschlossen für FB87

2200-Ø-BPGFB

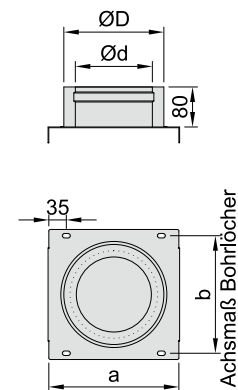

Ø d	Ø D	a	b	*Lg	€
130	180	240	215	1,39	68,60
150	200	260	235	1,61	71,10
160	213	290	265	1,92	72,70
180	230	290	265	1,97	76,50
200	250	310	285	2,22	88,30
250	300	360	335	2,91	111,90
300	350	410	385	3,68	123,20

 Basic plate FB87

 Plaque de base, FB87

Bodenplatte für Zwischenstütze

2200-Ø-BPZST

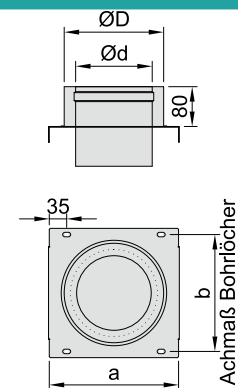
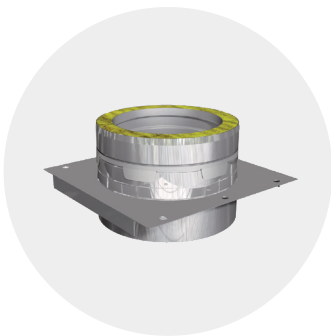

Ø d	Ø D	a	*Lg	€
130	180	240	2,10	106,40
150	200	260	2,36	108,80
160	213	290	2,69	111,60
180	230	290	2,76	115,10
200	250	310	3,03	124,20
250	300	360	3,72	205,10
300	350	410	4,42	227,90

 Intermediate plate with locking band

 Plaque de base intermédiaire avec cannelure pour colliers de fixation

 **STATISCHES BAUTEIL**

Bodenplatte Zwischenstütze für Schacht L90

2200-Ø-BPZL90

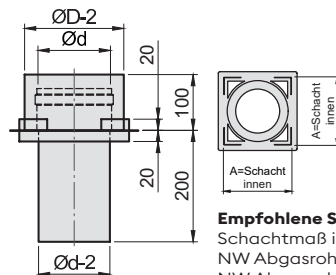
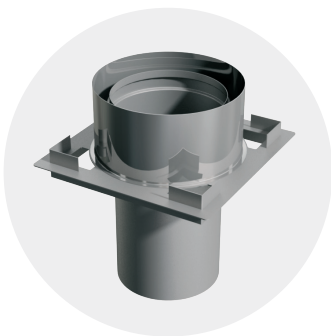

Ø d	Ø D	A	*Lg	€
130	180	200	1,18	86,80
150	200	220	1,33	87,50
160	213	230	1,56	88,30
180	230	270	1,60	89,70
200	250	270	1,72	93,60
250	300	330	2,12	127,10
300	350	370	2,55	139,60

 Base plate intermediate support for shaft L90

 Plaque de base support intermédiaire pour puits L90

Empfohlene Schachtmaße innen für Unterdruckbetrieb
Schachtmaß innen:
NW Abgasrohr + 70 mm (min) bei Unterdruckbetrieb
NW Abgasrohr + 100 mm (min) bei Überdruckbetrieb

*Lg=Legierungsgewicht: Lg (in kg) x Faktor Legierungszuschlag (in €/kg) = Netto-Aufpreis Legierungszuschlag

Rußtopf

2200-Ø-RTDW

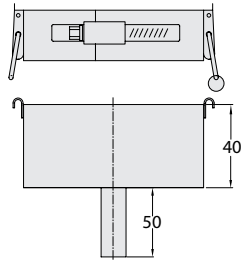

Ø d	*Lg	€
130	0,22	48,70
150	0,27	53,30
160	0,29	55,90
180	0,34	58,20
200	0,39	59,30
250	0,54	69,90
300	0,70	132,30

- Soot pot
- Pot à suie pour BPZ y compris fixations

HINWEIS

Typ RT passend für BPZ
Typ RTDW passend für Doppelwandige Bauteile

Prüföffnung Hochtemperatur

2200-Ø-PHDW

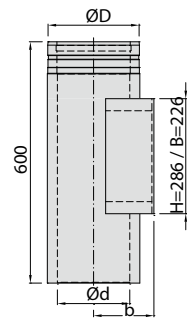

Ø d	Ø D	b	*Lg	€
130	180	125	4,10	323,50
150	200	135	4,47	343,90
160	213	142	4,67	359,70
180	230	150	5,01	375,50
200	250	160	5,37	406,80
250	300	185	6,27	502,10
300	350	210	7,18	547,30

- Inspection element, high temperature
- Élément d'inspection haute température

HINWEIS

Reinigungsöffnung Größe 120x180 mm

Prüföffnung Hochtemperatur mit statischem Klemmband

2200-Ø-PHDWST

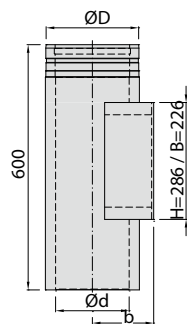

Ø d	Ø D	b	*Lg	€
130	180	125	4,10	345,30
150	200	135	4,47	366,90
160	213	142	4,67	384,10
180	230	150	5,01	402,30
200	250	160	5,37	436,20
250	300	185	6,27	536,50
300	350	210	7,18	586,50

- Inspection element, high temperature
- Élément d'inspection haute température

STATISCHES BAUTEIL

HINWEIS

Reinigungsöffnung Größe 120x180 mm

Prüföffnung Hochtemperatur mit Diffusionssperre

2200-Ø-PHDWU

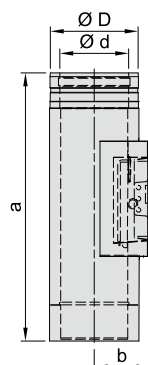
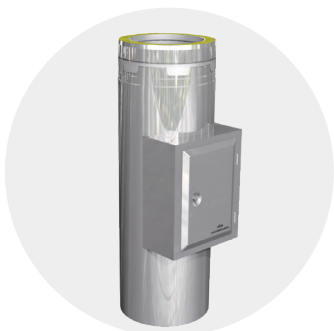

Ø d	Ø D	a	b	*Lg	€
130	180	600	125	4,22	358,30
150	200	600	135	4,59	378,70
160	213	600	142	4,79	394,50
180	230	600	150	5,13	410,30
200	250	600	160	5,49	441,60
250	300	600	185	6,39	491,30

- Inspection element, high temperature
- Élément d'inspection haute température

HINWEIS

Reinigungsöffnung Größe 120x180 mm

*Lg=Legierungsgewicht: Lg (in kg) x Faktor Legierungszuschlag (in €/kg) = Netto-Aufpreis Legierungszuschlag



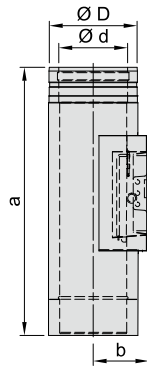

Prüföffnung Hochtemperatur mit Diffusionssperre und statischem Klemmband

2200-Ø-PHDWFUST



Ø d	Ø D	b	*Lg	€
130	180	125	4,22	380,10
150	200	135	4,59	401,70
160	213	142	4,79	418,90
180	230	150	5,13	437,10
200	250	160	5,49	471,00
250	300	185	6,39	571,30

 Inspection element, high temperature

 Élément d'inspection haute température

 **STATISCHES BAUTEIL**

 **HINWEIS**

Reinigungsöffnung Größe 120x180 mm

Prüföffnung Niedertemperatur

2200-Ø-PNDW

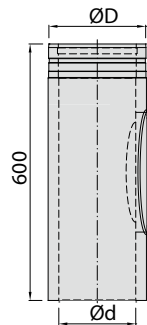

Ø d	Ø D	*Lg	€
130	180	2,75	348,70
150	200	3,12	371,50
160	213	3,32	388,90
180	230	3,66	405,40
200	250	4,02	439,80
250	300	4,92	542,80
300	350	5,83	590,40

 Inspection element, low temperature

 Élément d'inspection basse température

Prüföffnung Niedertemperatur mit statischem Klemmband

2200-Ø-PNDWST

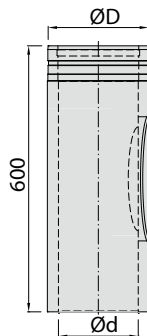

Ø d	Ø D	*Lg	€
130	180	2,75	370,50
150	200	3,12	394,50
160	213	3,32	413,20
180	230	3,66	432,30
200	250	4,02	469,30
250	300	4,92	577,20
300	350	5,83	629,70

 Inspection element, low temperature

 Élément d'inspection basse température

 **STATISCHES BAUTEIL**

Reinigungsöffnung mit Klappdeckel und Vitondichtung, max. 200°C

2200-Ø-L5KDVIT

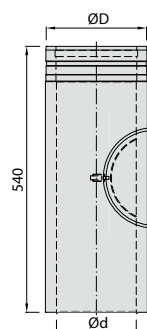

Ø d	Ø D	*Lg	€
130	180	2,25	168,00
150	200	2,85	191,00
160	213	3,04	198,80
180	230	3,34	206,70
200	250	3,66	219,20
250	300	4,48	286,00
300	350	5,29	325,10

 Cleaning hatch with hinged lid and gasket viton

 Élément d'inspection avec trappe de visite - joint pour manchon viton



*Lg=Legierungsgewicht: Lg (in kg) x Faktor Legierungszuschlag (in €/kg) = Netto-Aufpreis Legierungszuschlag

Reinigungsöffnung mit Klappdeckel und Vitondichtung, max. 200°C

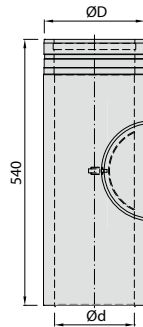
2200-Ø-L5KDVITST



Ø d	Ø D	*Lg	€
130	180	2,25	189,70
150	200	2,85	214,00
160	213	3,04	223,00
180	230	3,34	233,60
200	250	3,66	248,70
250	300	4,48	320,30
300	350	5,29	364,30

-  Cleaning hatch with hinged lid and gasket viton
-  Élément d'inspection avec trappe de visite - joint pour manchon viton

 **STATISCHES BAUTEIL**

Reinigungsöffnung mit Klappdeckel und Isothermdichtung, max. 600°C

2200-Ø-L5KDISO

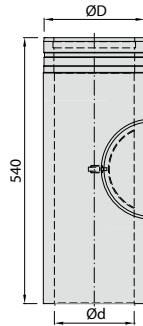

Ø d	Ø D	*Lg	€
130	180	2,25	156,20
150	200	2,85	178,00
160	213	3,04	185,90
180	230	3,34	188,30
200	250	3,66	200,80
250	300	4,48	266,40
300	350	5,29	305,30

-  Cleaning hatch with hinged lid and gasket isotherm
-  Élément d'inspection avec trappe de visite - joint pour manchon isotherm

Reinigungsöffnung mit Klappdeckel und Isothermdichtung, max. 600°C

2200-Ø-L5KDISOST

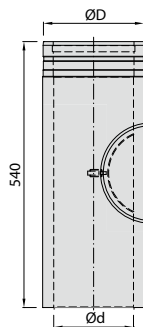

Ø d	Ø D	*Lg	€
130	180	2,25	177,90
150	200	2,85	201,00
160	213	3,04	210,10
180	230	3,34	215,20
200	250	3,66	230,30
250	300	4,48	300,70
300	350	5,29	344,50

-  Cleaning hatch with hinged lid and gasket isotherm
-  Élément d'inspection avec trappe de visite - joint pour manchon isotherm



 **STATISCHES BAUTEIL**

Reinigungsöffnung 540 mm mit Kugelfang, Rußtopf und Wandfutter

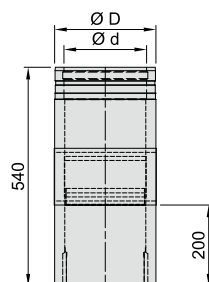
2200-Ø-L5KDKRW



Ø d	Ø D	*Lg	€
130	180	2,52	331,70
150	200	2,85	352,30
160	213	3,04	366,00
180	230	3,34	381,50
200	250	3,66	403,60

-  Cleaning hatch with hinged lid, ball trap, soot pot and wall lining
-  Élément d'inspection avec trappe de visite, pare-balles, Pot de suie et doublure murale

*Lg=Legierungsgewicht: Lg (in kg) x Faktor Legierungszuschlag (in €/kg) = Netto-Aufpreis Legierungszuschlag



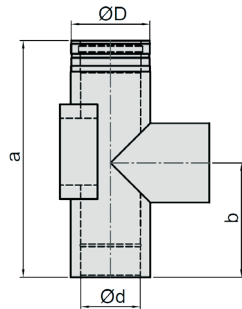

Kombibauteil gegenüberliegend

2200-Ø-F90PH



Ø d	Ø D	a	b	*Lg	€
130	180	600	305	4,10	512,40
150	200	600	290	4,47	553,00
160	213	600	270	4,67	588,60
180	230	600	305	5,01	624,90
200	250	600	290	5,37	696,40
250	300	610	315	6,27	886,10
300	350	660	340	7,18	1.014,70

-  Combination part
-  Pièce combinée

Feuerungsanschluss 90° Hochtemperatur mit Diffusionsperre

2200-Ø- F90PHFU

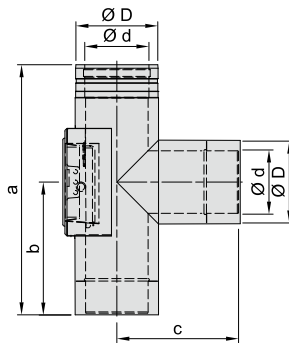
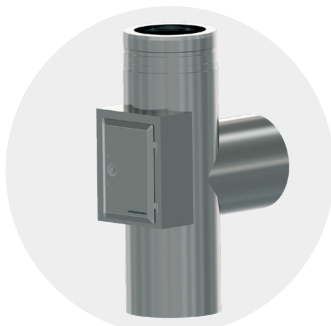

Ø d	Ø D	a	b	c	*Lg	€
130	180	600	305	255	4,22	547,40
150	200	600	290	265	4,59	588,10
160	213	600	270	270	4,79	623,50
180	230	600	305	280	5,13	659,80
200	250	600	315	290	5,49	731,30
250	300	610	315	315	6,39	840,70



-  T 90° firing connection high temperature with moisture barrier
-  T-90° haute température avec Barrière contre l'humidité

Feuerungsanschluss 45°

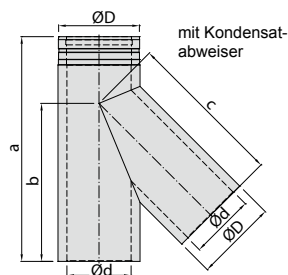
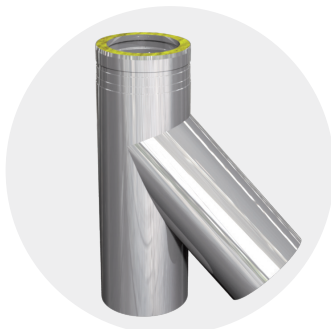
2200-Ø-F45



Ø d	Ø D	a	b	c	*Lg	€
130	180	560	382	382	3,31	253,40
150	200	600	406	406	4,02	292,00
160	213	610	419	419	4,39	312,40
180	230	630	443	443	5,04	317,90
200	250	660	467	467	5,81	375,50
250	300	730	527	527	7,96	498,70
300	350	800	588	588	10,50	616,40



-  T 45° firing connection, isolated
-  T 45° raccordement de chaudière, isolé

Feuerungsanschluss 90° Hochtemperatur

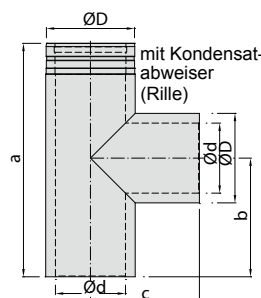
2200-Ø-F90H



Ø d	Ø D	a	b	c	*Lg	€
130	180	600	305	255	3,38	189,10
150	200	600	290	265	3,84	209,40
160	213	600	270	270	4,09	229,00
180	230	600	305	280	4,53	249,50
200	250	600	290	290	5,01	289,70
250	300	610	315	315	6,21	384,40
300	350	660	340	340	7,86	467,60

-  T 90° firing connection high temperature
-  T 90° raccordement de chaudière haute température

 **HINWEIS**

Auch Ausführung 87° auf Anfrage möglich.



*Lg=Legierungsgewicht: Lg (in kg) x Faktor Legierungszuschlag (in €/kg) = Netto-Aufpreis Legierungszuschlag

Feuerungsanschluss 90° Niedertemperatur

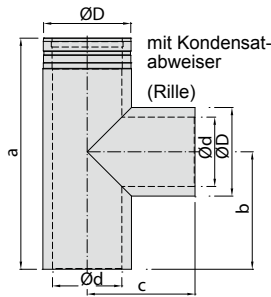
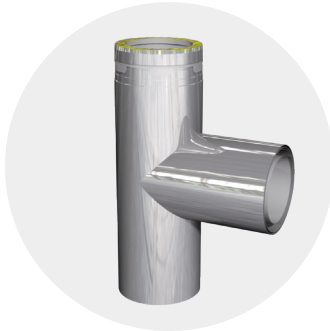
2200-Ø-F90N



Ø d	Ø D	a	b	c	*Lg	€
130	180	600	305	255	3,38	196,20
150	200	600	290	265	3,84	217,30
160	213	600	270	270	4,09	237,70
180	230	600	305	280	4,53	258,20
200	250	600	290	290	5,01	299,90
250	300	610	315	315	6,21	384,40
300	350	660	340	340	7,86	467,60

-  T-90° firing connection low temperature
-  T 90° raccordement de chaudière basse température

 **HINWEIS**



Auch Ausführung 87° auf Anfrage möglich.

Feuerungsanschluss 90° Hochtemperatur mit Wandfutter und Sichtblende

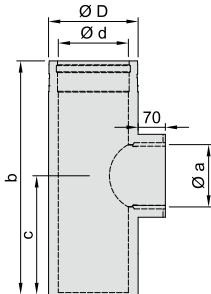
2200-Ø-F90HWF



Ø d	Ø D	a	b	c	*Lg	€
130	180	600	305	255	3,38	255,60
150	200	600	290	265	3,84	281,20
160	213	600	270	270	4,09	303,10
180	230	600	305	280	4,53	327,70
200	250	600	315	290	5,01	374,10
250	300	610	315	315	6,21	442,50



-  T-90° firing connection high temperature with wall lining and screen
-  T-90° raccordement de chaudière haute température avec Doublure murale et cache

Feuerungsanschluss mit innenliegendem Bogen 87°

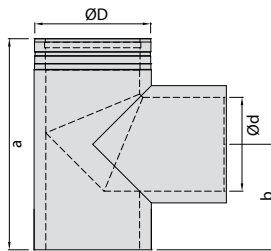
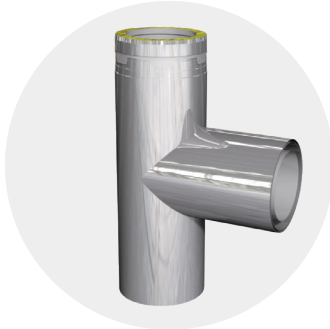
2250-ØFB87



Ø d	Ø D	a	b	*Lg	€
130	180	600	305	3,90	235,60
150	200	600	290	4,38	260,70
160	213	600	270	4,62	285,30
180	230	600	305	5,10	309,90
200	250	600	290	5,59	359,90
250	300	610	315	6,82	461,20
300	350	660	340	8,07	561,00

-  Firing connection with internal elbow 87°
-  Té de raccordement avec coude intégré de 87°

 **HINWEIS**



Bodenplatte geschlossen für FB87 erhältlich

Übergangsstück DW /EW incl. Wärmedämmung

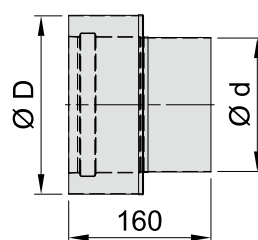
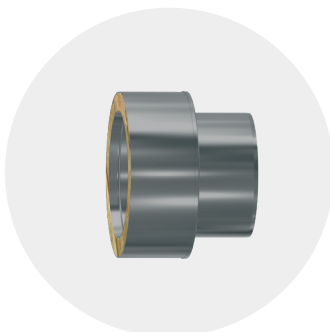
2200-Ø-EÜ



Ø d	Ø D	*Lg	€
130	180	0,35	58,40
150	200	0,41	63,00
160	213	0,43	64,60
180	230	0,49	68,20
200	250	0,60	74,50
250	300	0,75	92,20
300	350	0,90	97,90

-  Adapter with collar
-  Adaptateur avec collerette de recouvrement pour DP/SP



*Lg=Legierungsgewicht: Lg (in kg) x Faktor Legierungszuschlag (in €/kg) = Netto-Aufpreis Legierungszuschlag

Übergangsstück DW /EW incl. Wärmedämmung mit Wandfutter

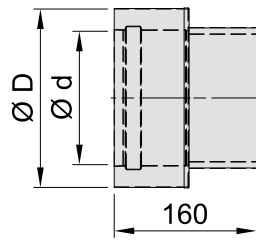
2200-Ø-EÜWF



Ø d	Ø D	*Lg	€
130	180	1,16	73,30
150	200	1,30	79,10
160	213	1,36	81,70
180	230	1,50	86,20
200	250	1,63	92,90
250	300	1,96	112,80
300	350	2,29	119,40

-  Adapter CD/CE with double wall neck
-  Adaptateur DP/SP pour passage mural

 **HINWEIS**



passend für Rauchrohr 2 mm

Übergangsstück DW /EW konisch

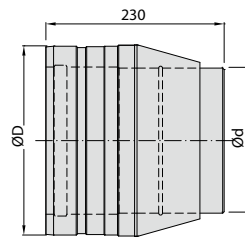
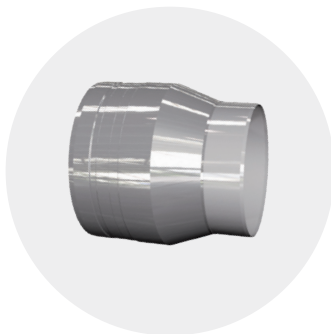
2200-Ø-EÜK



Ø d	Ø D	*Lg	€
130	180	1,32	79,70
150	200	1,46	89,10
160	213	1,53	92,20
180	230	1,68	93,20
200	250	1,82	96,30
250	300	2,19	130,10
300	350	2,55	156,00



-  Adapter single/double wall conical
-  Adaptateur de recouvrement pour DP/SP conique

Übergangsstück complex D / cosmos D

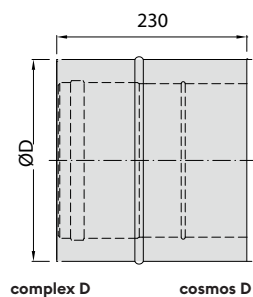
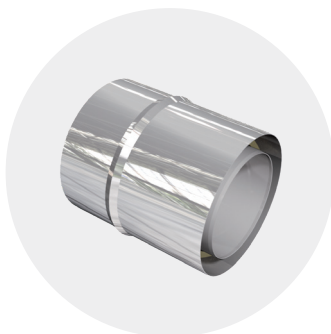
2200-Ø-EÜ C/CST



Ø d	Ø D	*Lg	€
130	180	1,32	88,30
150	200	1,46	94,90
160	213	1,53	98,60
180	230	1,68	105,20
200	250	1,82	113,90
250	300	2,19	136,80
300	350	2,55	147,70



-  Adapter double wall/ conical
-  Adaptateur de recouvrement pour DP/SP conique

Übergangsstück cosmos D / complex D

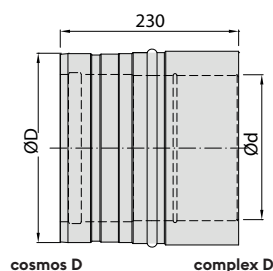
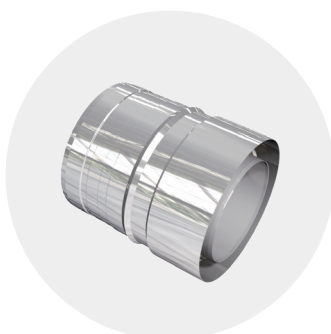
2200-Ø-EÜ CST/C



Ø d	Ø D	*Lg	€
130	180	1,32	88,30
150	200	1,46	94,90
160	213	1,53	98,60
180	230	1,68	105,20
200	250	1,82	113,90
250	300	2,19	136,80
300	350	2,55	147,70

-  Adapter conical/double wall
-  Adaptateur de recouvrement pour SP conique/DP

*Lg=Legierungsgewicht: Lg (in kg) x Faktor Legierungszuschlag (in €/kg) = Netto-Aufpreis Legierungszuschlag

Längenelement 250 mm, kürzbar mit integriertem Wandfutter

2200-Ø-L3ETWF

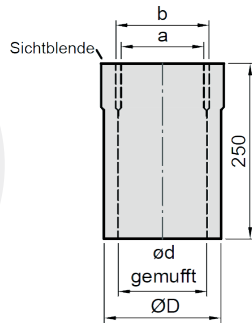
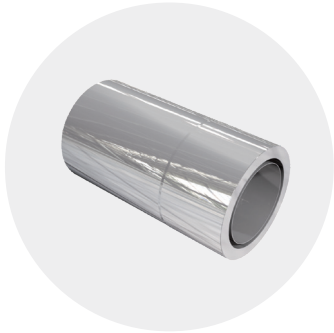

Ø d	Ø D	a	b	*Lg	€
130	180	122	140	0,98	108,00
150	200	142	160	1,10	118,90
160	213	152	170	1,21	127,50
180	230	172	190	1,29	137,20
200	250	192	210	1,42	145,90
250	300	242	260	1,73	177,50
300	350	292	310	2,09	229,80

 Length element, 250 mm, cuttable, with double wall neck

 Élémt droit 250 mm, ajustable pour passage mural

 **HINWEIS**

passend für Rauchrohr 2 mm

Längenelement 500 mm, kürzbar mit integriertem Wandfutter

2200-Ø-L5ETWF

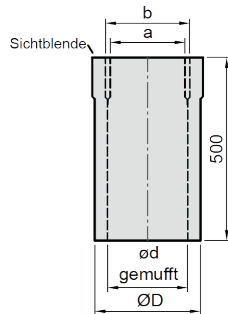
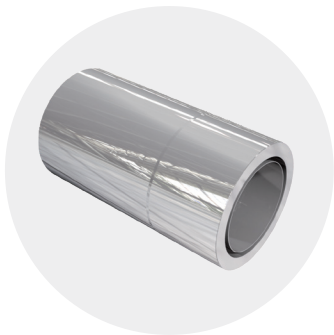

Ø d	Ø D	a	b	*Lg	€
130	180	122	140	2,16	132,00
150	200	142	160	2,44	145,00
160	213	152	170	2,54	154,40
180	230	172	190	2,87	163,80
200	250	192	210	3,15	180,10
250	300	242	260	3,85	222,80
300	350	292	310	4,18	262,00

 Length element, 500 mm, cuttable, with double wall neck

 Élémt droit 500 mm, ajustable pour passage mural

 **HINWEIS**

passend für Rauchrohr 2 mm

Längenelement 1000 mm, kürzbar mit integriertem Wandfutter

2200-Ø-L10ETWF

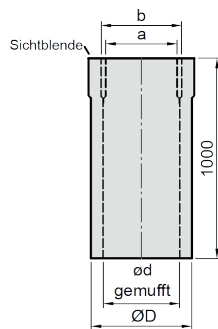
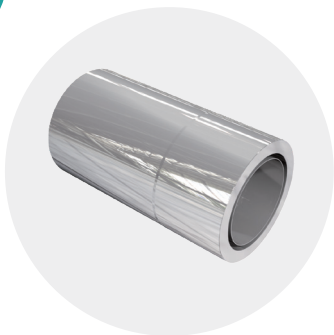

Ø d	Ø D	a	b	*Lg	€
130	180	122	140	4,11	186,50
150	200	142	160	4,64	206,00
160	213	152	170	4,93	217,80
180	230	172	190	5,44	230,50
200	250	192	210	5,97	260,80
250	300	242	260	7,30	331,60
300	350	292	310	8,40	406,20

 Length element 1000 mm, cuttable, with double wall neck

 Élémt droit 1000mm, ajustable pour passage mural

 **HINWEIS**

passend für Rauchrohr 2 mm

Längenelement 1080 mm

2200-Ø-L10

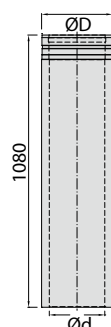
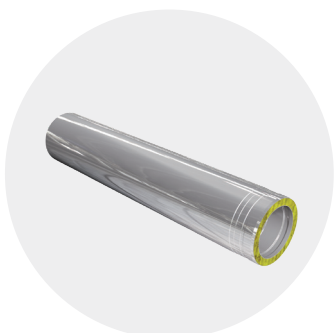

Ø d	Ø D	*Lg	€
130	180	5,05	149,70
150	200	5,70	166,80
160	213	6,07	178,50
180	230	6,67	189,00
200	250	7,32	218,10
250	300	8,95	294,60
300	350	10,58	349,60

 Length element 1080 mm

 Élémt droit 1080 mm

*Lg=Legierungsgewicht: Lg (in kg) x Faktor Legierungszuschlag (in €/kg) = Netto-Aufpreis Legierungszuschlag

Längenelement 1080 mm - statisch

2200-Ø-L10ST

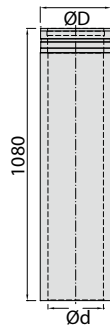
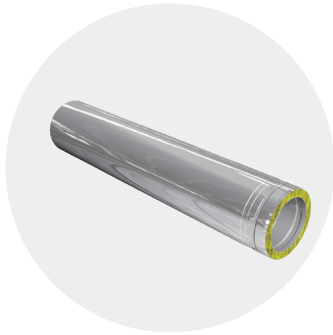

Ø d	Ø D	*Lg	€
130	180	5,05	171,40
150	200	5,70	189,80
160	213	6,07	202,90
180	230	6,67	215,80
200	250	7,32	247,50
250	300	8,95	328,90
300	350	10,58	388,80

 Length element 1080 mm, static

 Élément droit 1080 mm

 **STATISCHES BAUTEIL**

Längenelement 540 mm

2200-Ø-L5

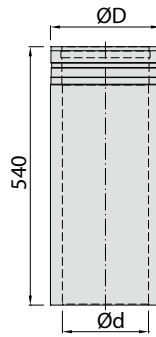
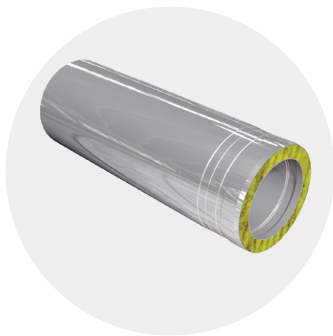

Ø d	Ø D	*Lg	€
130	180	2,52	86,70
150	200	2,85	96,10
160	213	3,04	103,80
180	230	3,34	111,80
200	250	3,66	124,30
250	300	4,48	167,50
300	350	5,29	197,60

 Length element 540 mm

 Élément droit 540 mm

Längenelement 540 mm - statisch

2200-Ø-L5ST

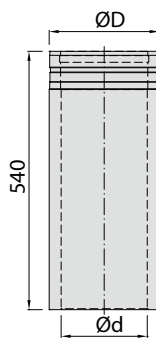
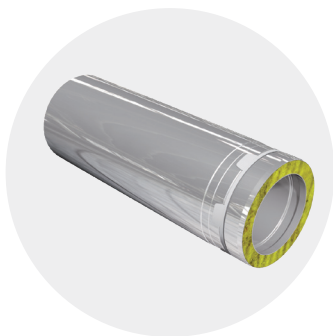

Ø d	Ø D	*Lg	€
130	180	2,52	108,40
150	200	2,85	119,00
160	213	3,04	128,10
180	230	3,34	138,70
200	250	3,66	153,70
250	300	4,48	201,80
300	350	5,29	236,80

 Length element 540mm

 Élément droit 540 mm

 **STATISCHES BAUTEIL**

Längenelement 360 mm

2200-Ø-L3

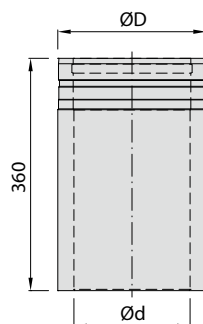
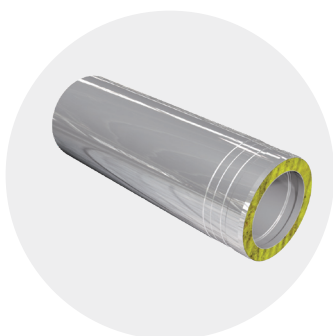

Ø d	Ø D	*Lg	€
130	180	1,68	65,20
150	200	1,90	73,20
160	213	2,02	81,00
180	230	2,22	89,00
200	250	2,44	93,60
250	300	2,98	125,10
300	350	3,53	164,40

 Length element 360mm

 Élément droit 360 mm



*Lg=Legierungsgewicht: Lg (in kg) x Faktor Legierungszuschlag (in €/kg) = Netto-Aufpreis Legierungszuschlag

Längenelement 360 mm - statisch

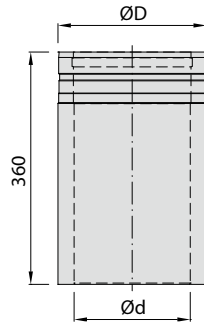
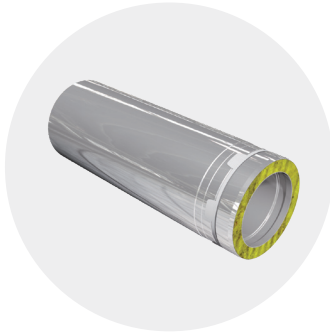
2200-Ø-L3ST



Ø d	Ø D	*Lg	€
130	180	1,68	87,00
150	200	1,90	96,20
160	213	2,02	105,30
180	230	2,22	115,80
200	250	2,44	123,10
250	300	2,98	159,40
300	350	3,53	203,60

-  Length element 360mm
-  Élément droit 360 mm



 **STATISCHES BAUTEIL**

Längenelement mit Meßstutzen

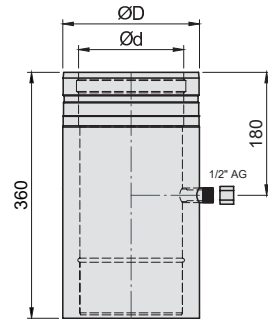
2200-Ø-LM



Ø d	Ø D	*Lg	€
130	180	1,68	121,80
150	200	1,90	129,80
160	213	2,02	137,80
180	230	2,22	145,70
200	250	2,44	150,30
250	300	2,98	198,30
300	350	3,53	246,00

-  Length element with measuring opening
-  Élément droit avec manchon de mesure

Längenausgleichselement 330 - 420 mm

2200-Ø-LA

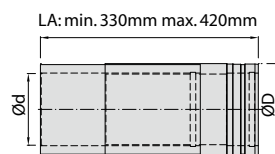
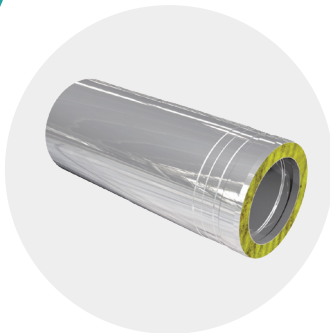

Ø d	Ø D	*Lg	€
130	180	2,34	133,70
150	200	2,64	150,30
160	213	2,81	166,10
180	230	3,09	181,80
200	250	3,39	190,40
250	300	4,14	276,30
300	350	4,09	371,50

-  Adjustable length element 330 - 420 mm
-  Élément adaptable de 330- 420 mm

Längenausgleichselement 420 - 620 mm

2200-Ø-LA5

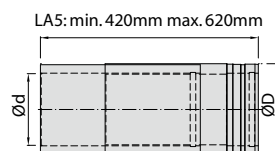
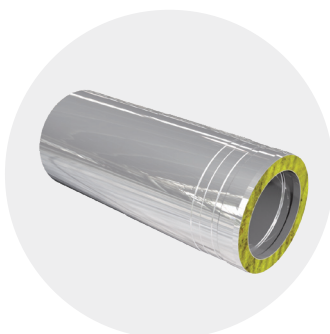

Ø d	Ø D	*Lg	€
130	180	3,27	180,20
150	200	3,69	199,90
160	213	3,94	216,50
180	230	4,33	233,10
200	250	4,75	259,80
250	300	5,80	381,10
300	350	6,86	462,40

-  Adjustable length element 420 - 620 mm
-  Élément adaptable de 420 - 620 mm

*Lg=Legierungsgewicht: Lg (in kg) x Faktor Legierungszuschlag (in €/kg) = Netto-Aufpreis Legierungszuschlag

Bogen 90°

2200-Ø-B90

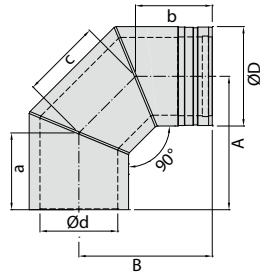
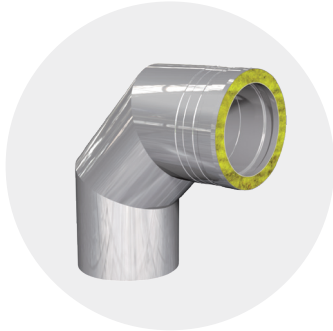

Ø d	Ø D	A	B	a	b	c	*Lg	€
130	180	287	282	170	165	165	2,31	233,80
150	200	297	292	174	169	173	2,69	246,30
160	213	303	298	177	172	179	2,93	257,30
180	230	312	307	180	175	186	3,30	268,50
200	250	322	314	184	179	194	3,73	280,20
250	300	347	342	195	190	215	4,89	352,40
300	350	372	367	205	200	255	6,17	424,10

 Elbow 90°

 Coude 90°

Bogen 90° mit Prüföffnung

2200-Ø-BP90H / BP90N

BP90H max. 600°C | BP90N max. 200°C

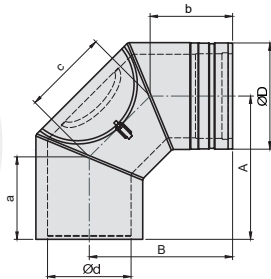
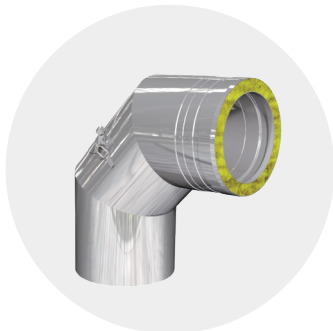

Ø d	Ø D	A	B	a	b	c	*Lg	€
130	180	287	282	170	165	165	2,31	272,30
150	200	297	292	174	169	173	2,69	285,60
160	213	303	298	177	172	179	2,93	298,20
180	230	312	307	180	175	186	3,30	309,20
200	250	322	314	184	179	194	3,73	322,70
250	300	347	342	195	190	215	4,89	402,70
300	350	372	367	205	200	255	6,17	456,40

 Elbow 90° with inspection door

 Coude 90° avec élément d'inspection

 **HINWEIS**

Prüföffnung nicht in Kondensatfluß einbauen!

Bogen 87°

2200-Ø-B87

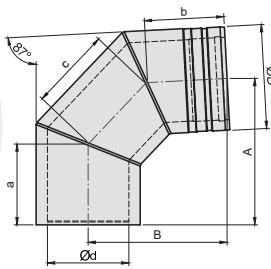
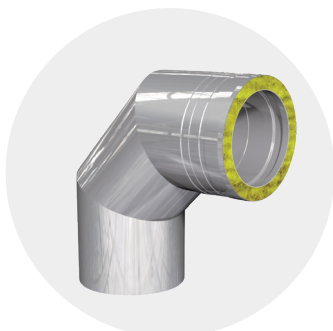

Ø d	Ø D	A	B	a	b	c	*Lg	€
130	180	295	275	169	164	162	2,31	233,80
150	200	305	284	173	168	170	2,69	246,30
160	213	311	291	175	170	175	2,93	257,30
180	230	320	299	179	174	182	3,30	268,50
200	250	330	308	183	178	190	3,73	280,20
250	300	355	332	193	188	210	4,89	352,40
300	350	380	356	203	198	230	6,17	424,10

 Elbow 87°

 Coude 87°

Bogen 87° mit Prüföffnung

2200-Ø-BP87H / BP87N

BP87H max. 600°C | BP87N max. 200°C

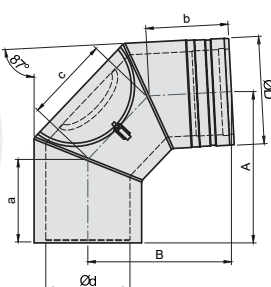
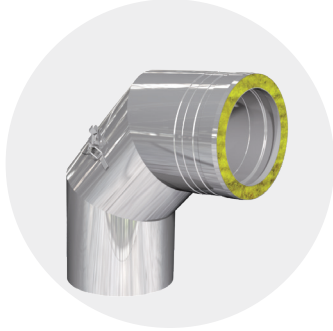

Ø d	Ø D	A	B	a	b	c	*Lg	€
130	180	295	275	169	164	162	2,31	272,30
150	200	305	284	173	168	170	2,69	285,60
160	213	311	291	175	170	175	2,93	298,20
180	230	320	299	179	174	182	3,30	309,20
200	250	330	308	183	178	190	3,73	322,70
250	300	355	332	193	188	210	4,89	402,70
300	350	380	356	203	198	230	6,17	456,40

 Elbow 87° with inspection door

 Coude 87° avec élément d'inspection

 **HINWEIS**

Prüföffnung nicht in Kondensatfluß einbauen!

*Lg=Legierungsgewicht: Lg (in kg) x Faktor Legierungszuschlag (in €/kg) = Netto-Aufpreis Legierungszuschlag

Bogen 45°

2200-Ø-B45

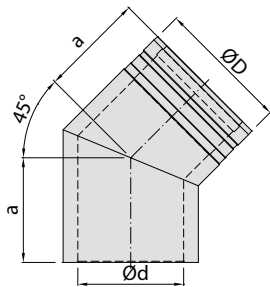

Ø d	Ø D	a	b	*Lg	€
130	180	170	165	1,56	113,40
150	200	174	169	1,80	116,50
160	213	177	172	1,95	121,80
180	230	180	175	2,20	129,30
200	250	184	179	2,47	134,70
250	300	195	190	3,18	164,70
300	350	205	200	3,96	225,10

 Elbow 45°

 Coude 45°

Bogen 45° statisch

2200-Ø-B45 ST

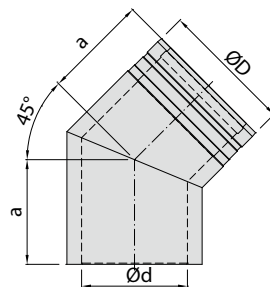

Ø d	Ø D	a	b	*Lg	€
130	180	170	165	1,56	135,00
150	200	174	169	1,80	139,40
160	213	177	172	1,95	146,30
180	230	180	175	2,20	156,00
200	250	184	179	2,47	164,20
250	300	195	190	3,18	199,00
300	350	205	200	3,96	264,40

 Elbow 45°

 Coude 45°

 **STATISCHES BAUTEIL**

Bogen 45° mit Prüfföffnung

2200-Ø-BP45KDISO / KDVIT

BP45KDISO max. 600°C | BP45KDVIT max. 200°C

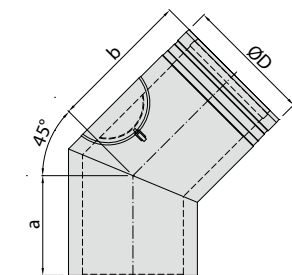
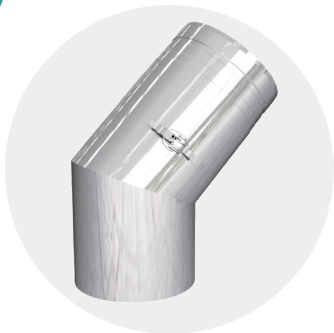

Ø d	Ø D	a	b	*Lg	€
130	180	166	270	2,04	178,30
150	200	170	265	2,29	189,40
160	213	173	295	2,66	202,80
180	230	176	330	3,13	218,10
200	250	180	360	3,66	228,10
250	300	195	380	4,73	300,40
300	350	205	370	4,93	408,30

 Elbow 45° with inspection hatch

 Coude 45° avec élément d'inspection

 **HINWEIS**

Prüfföffnung nicht in
Kondensatfluß einbauen!

Prüfföffnung auch in der
Einsteckseite möglich

Bogen 30°

2200-Ø-B30

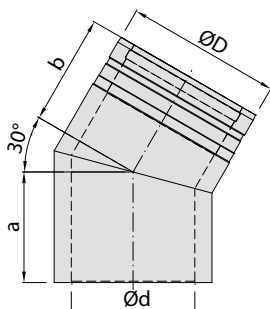

Ø d	Ø D	a	b	*Lg	€
130	180	157	152	1,44	113,40
150	200	159	154	1,66	116,50
160	213	161	156	1,78	121,80
180	230	163	158	1,99	129,30
200	250	166	161	2,21	134,70
250	300	173	168	2,82	164,70
300	350	179	174	3,47	225,10

 Elbow 30°

 Coude 30°

*Lg=Legierungsgewicht: Lg (in kg) x Faktor Legierungszuschlag (in €/kg) = Netto-Aufpreis Legierungszuschlag

Bogen 30° statisch

2200-Ø-B30 ST

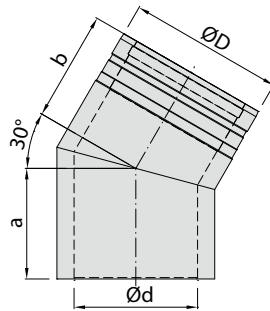

Ø d	Ø D	a	b	*Lg	€
130	180	157	152	1,44	135,00
150	200	159	154	1,66	139,40
160	213	161	156	1,78	146,30
180	230	163	158	1,99	156,00
200	250	166	161	2,21	164,20
250	300	173	168	2,82	199,00
300	350	179	174	3,47	264,40

 Elbow 30°

 Coude 30°

 **STATISCHES BAUTEIL**

Bogen 15°

2200-Ø-B15

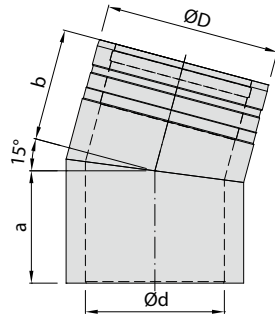

Ø d	Ø D	a	b	*Lg	€
130	180	144	139	1,33	113,40
150	200	146	141	1,51	116,50
160	213	147	142	1,62	121,80
180	230	148	143	1,79	129,30
200	250	149	144	1,98	134,70
250	300	152	147	2,49	164,70
300	350	156	151	3,00	225,10

 Elbow 15°

 Coude 15°

Bogen 15° statisch

2200-Ø-B15ST

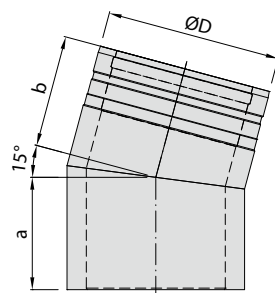

Ø d	Ø D	a	b	*Lg	€
130	180	144	139	1,33	135,00
150	200	146	141	1,51	139,40
160	213	147	142	1,62	146,30
180	230	148	143	1,79	156,00
200	250	149	144	1,98	164,20
250	300	152	147	2,49	199,00
300	350	156	151	3,00	264,40

 Elbow 15°

 Coude 15°

 **STATISCHES BAUTEIL**

Blitzschutzklemme

2200-Ø-BK

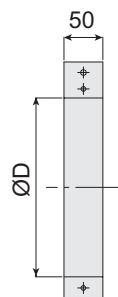
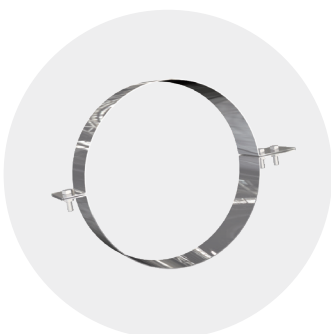

Ø d	Ø D	*Lg	€
130	180	-	22,40
150	200	-	23,10
160	213	-	23,10
180	230	-	23,80
200	250	-	23,80
250	300	-	24,60
300	350	-	28,10

 Bracket for flash security

 Bride paratonnerre



*Lg=Legierungsgewicht: Lg (in kg) x Faktor Legierungszuschlag (in €/kg) = Netto-Aufpreis Legierungszuschlag

Wandhalter (Wandabstand 50 mm)

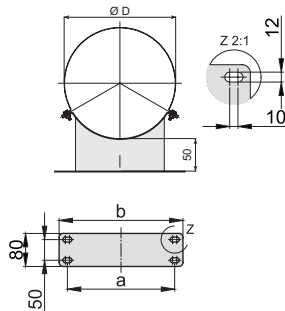
2200-Ø-W



Ø d	Ø D	a	b	*Lg	€
130	180	180	220	-	60,60
150	200	200	240	-	61,90
160	213	213	250	-	61,90
180	230	230	270	-	63,30
200	250	250	290	-	67,40
250	300	300	340	-	74,50
300	350	350	390	-	89,60



-  Wall bracket, distance 50 mm
-  Bride de fixation murale, distance 50 mm

Wandhalter (Wandabstand 75 mm)

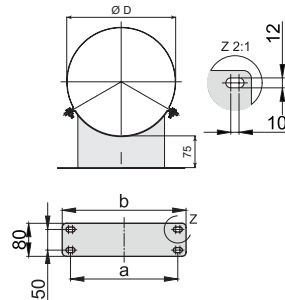
2200-Ø-W75



Ø d	Ø D	a	b	*Lg	€
130	180	180	220	-	63,80
150	200	200	240	-	64,90
160	213	213	250	-	64,90
180	230	230	270	-	66,60
200	250	250	290	-	70,80
250	300	300	340	-	78,40
300	350	350	390	-	89,60



-  Wall bracket, distance 75 mm
-  Bride de fixation murale, distance 75 mm

Wandhalter verstellbar 50 - 90 mm

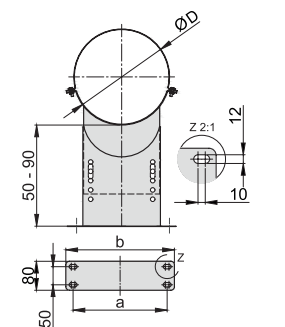
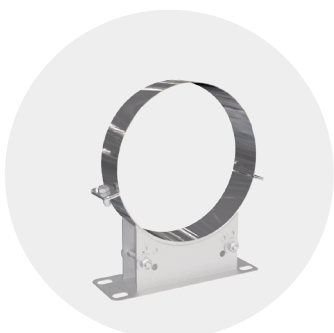
2200-Ø-WHV



Ø d	Ø D	a	b	*Lg	€
130	180	180	220	-	79,00
150	200	200	240	-	85,20
160	213	213	250	-	85,20
180	230	230	270	-	92,20
200	250	250	290	-	99,40
250	300	300	340	-	117,50
300	350	350	390	-	121,50



-  Wall bracket, adjustable, 50 - 90 mm
-  Bride de fixation réglable murale 50 - 90 mm

Wandhalter verstellbar 90 - 160 mm

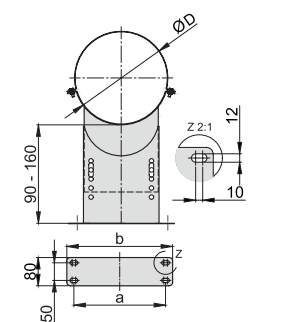
2200-Ø-WHV9



Ø d	Ø D	a	b	*Lg	€
130	180	180	220	-	89,10
150	200	200	240	-	93,20
160	213	213	250	-	93,20
180	230	230	270	-	100,10
200	250	250	290	-	108,10
250	300	300	340	-	127,70
300	350	350	390	-	133,30

-  Wall bracket, adjustable, 90 - 160 mm
-  Bride de fixation réglable murale 90 - 160 mm



*Lg=Legierungsgewicht: Lg (in kg) x Faktor Legierungszuschlag (in €/kg) = Netto-Aufpreis Legierungszuschlag

Wandhalter verstellbar 160 - 250 mm

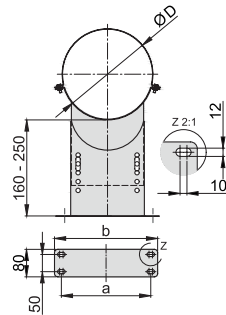
2200-Ø-WHV16



Ø d	Ø D	a	b	*Lg	€
130	180	180	220	-	101,80
150	200	200	240	-	105,00
160	213	213	250	-	105,00
180	230	230	270	-	113,70
200	250	250	290	-	122,10
250	300	300	340	-	145,10
300	350	350	390	-	153,60



-  Wall bracket, adjustable, 160 - 250 mm
-  Bride de fixation réglable murale 160 - 250 mm

Wandhalter verstellbar 250 - 400 mm

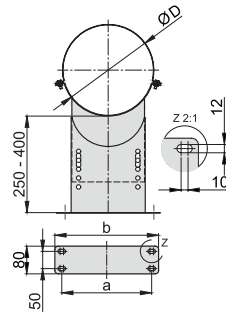
2200-Ø-WHV25



Ø d	Ø D	a	b	*Lg	€
130	180	180	220	-	137,90
150	200	200	240	-	142,70
160	213	213	250	-	142,70
180	230	230	270	-	153,60
200	250	250	290	-	164,80
250	300	300	340	-	193,10
300	350	350	390	-	207,10

-  Wall bracket, adjustable, 250 - 400 mm
-  Bride de fixation réglable murale 250 - 400 mm

Wandhalterverlängerung, verstellbar 100 - 250 mm

2200-Ø-WVLK

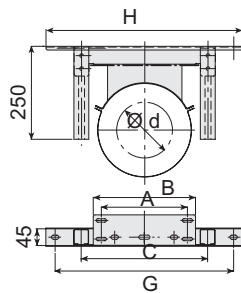
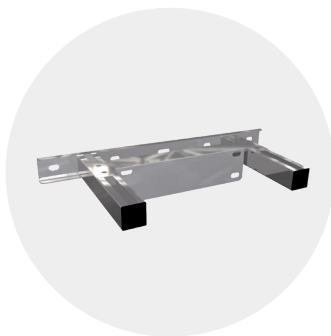

Ø d	A	B	C	G	H	*Lg	€
130	190	225	290	430	480	-	108,60
150	190	225	290	430	480	-	108,60
160	230	275	340	480	530	-	111,70
180	230	275	340	480	530	-	111,70
200	230	275	340	480	530	-	111,70
250	280	325	390	480	530	-	116,00
300	350	375	440	530	580	-	125,00

-  Wall bracket extension, adjustable 100 - 250 mm
-  Rallonge de fixation murale, réglable 100 - 250 mm

Wandhalterverlängerung, verstellbar 100 - 500 mm

2200-Ø-WVLL

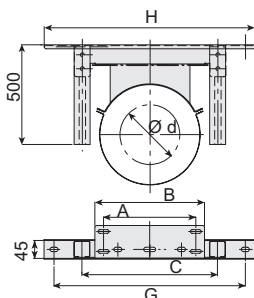

Ø d	A	B	C	G	H	*Lg	€
130	190	225	290	430	480	-	123,10
150	190	225	290	430	480	-	123,10
160	230	275	340	480	530	-	127,00
180	230	275	340	480	530	-	127,00
200	230	275	340	480	530	-	127,00
250	280	325	390	480	530	-	131,60
300	350	375	440	530	580	-	141,20

-  Wall bracket extension, adjustable 100 - 500 mm
-  Rallonge de fixation murale, réglable 100 - 500 mm

*Lg=Legierungsgewicht: Lg (in kg) x Faktor Legierungszuschlag (in €/kg) = Netto-Aufpreis Legierungszuschlag

Sparrenbefestigung

2200-Ø-SS

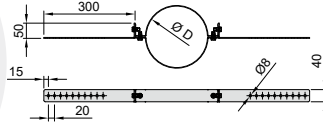

Ø d	Ø D	*Lg	€
130	180	-	59,80
150	200	-	60,60
160	213	-	61,20
180	230	-	61,60
200	250	-	62,70
250	300	-	65,80
300	350	-	81,10

 Rafter bracket

 Fixation aux chevrons

Wandhalter für Sparrendach verstellbar, Ring 360° drehbar

2200-Ø-WHVS / WHVS9 / WHVS16 / WHVS25

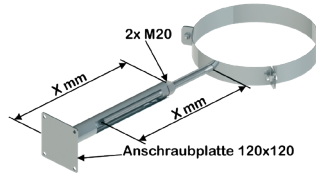

Ø d	Ø D	*Lg	€
Verstellbereich 50 - 90 mm - Preis siehe Wandhalter 2200-Ø-WHV			
Verstellbereich 90 - 160 mm - Preis siehe Wandhalter 2200-Ø-WHV9			
Verstellbereich 160 - 250 mm - Preis siehe Wandhalter 2200-Ø-WHV16			
Verstellbereich 250 - 400mm - Preis siehe Wandhalter 2200-Ø-WHV25			

 Wall bracket for rafter roof, rotatable

 Support mural pour toit à chevrons, pivotant

 **HINWEIS**

Verstellbereiche identisch zu unseren Wandhaltern WHV/WHV9/WHV16/WHV25

Wandhalter für Sparrendach verstellbar, Ring 360° drehbar und schwenkbar

2200-Ø-WHVSd / WHVSd9 / WHVSd16 / WHVSd25

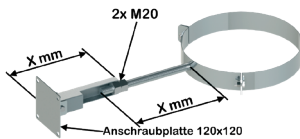

Ø d	Ø D	*Lg	€
Verstellbereich 50 - 90 mm - Preis siehe Wandhalter 2200-Ø-WHV + Aufpreis 60 €			
Verstellbereich 90 - 160 mm - Preis siehe Wandhalter 2200-Ø-WHV9 + Aufpreis 60 €			
Verstellbereich 160 - 250 mm - Preis siehe Wandhalter 2200-Ø-WHV16 + Aufpreis 60 €			
Verstellbereich 250 - 400mm - Preis siehe Wandhalter 2200-Ø-WHV25 + Aufpreis 60 €			

 Wall bracket for rafter roof, rotatable and swivelling

 Support mural pour toit à chevrons, pivotant et inclinable

 **HINWEIS**

Verstellbereiche identisch zu unseren Wandhaltern WHV/WHV9/WHV16/WHV25

*Lg=Legierungsgewicht: Lg (in kg) x Faktor Legierungszuschlag (in €/kg) = Netto-Aufpreis Legierungszuschlag



Dreipunktbefestigung für Seilabspannung (ohne Seil)

2200-Ø-SA

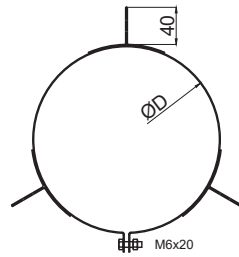
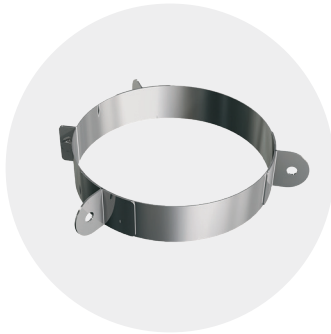

Ø d	Ø D	*Lg	€
130	180	-	41,20
150	200	-	41,20
160	213	-	41,70
180	230	-	42,10
200	250	-	42,80
250	300	-	44,40
300	350	-	45,10



Bracket for static wires



Bride de haubanage avec 3 points de fixation

Zweipunktbefestigung für Teleskopstangen

2200-Ø-SA2

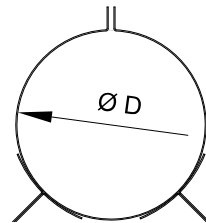
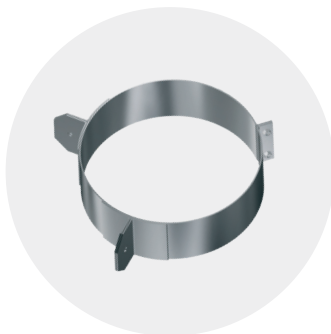

Ø d	Ø D	*Lg	€
130	180	-	41,20
150	200	-	41,20
160	213	-	41,70
180	230	-	42,10
200	250	-	42,80
250	300	-	44,40
300	350	-	45,10



Two-point fastening for telescopic rods



Fixation en deux points pour perches télescopiques

Stützfuß mit Schale - 2 Varianten

2200-Ø-SP1 / SP2

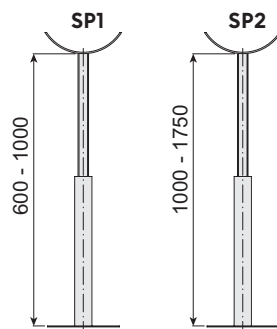

Ø d	*Lg	€
SP 1		
80 - 250		153,60
300 - 600		165,50
SP 2		
80 - 250		228,50
300 - 600		245,00



Support leg - with semicircular shell



Pied de support - avec coque demi rond



Ausführung mit Gegenschale:
Aufpreis: 15%

Mündungsabschluss

2200-Ø-M

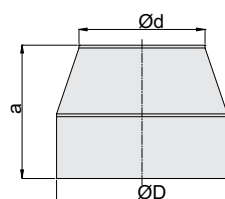

Ø d	Ø D	a	*Lg	€
130	180	190	1,07	51,40
150	200	190	1,18	61,60
160	213	190	1,24	62,40
180	230	190	1,36	63,20
200	250	190	1,48	64,70
250	300	190	1,77	90,30
300	350	190	2,06	112,90



Top stub



Finition conique



*Lg=Legierungsgewicht: Lg (in kg) x Faktor Legierungszuschlag (in €/kg) = Netto-Aufpreis Legierungszuschlag

Mündungsabschluss, 540mm lang

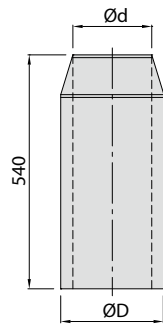
2200-Ø-M5



Ø d	Ø D	*Lg	€
130	180	2,52	137,80
150	200	2,85	157,60
160	213	3,04	166,10
180	230	3,34	174,70
200	250	3,66	189,00
250	300	4,48	272,20
300	350	5,29	333,60



-  Top stub, 540 mm
-  Finition conique, 540 mm

Regenhaube mit Mündungsabschluss

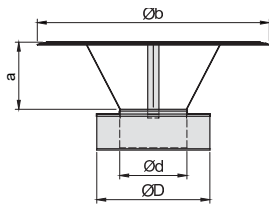
2200-Ø-RH



Ø d	Ø D	a	b	*Lg	€
130	180	130	360	1,07	90,00
150	200	150	360	1,18	108,80
160	213	160	360	1,24	113,70
180	230	180	450	1,36	118,20
200	250	200	450	1,48	128,40
250	300	250	450	1,77	187,30
300	350	250	500	2,06	240,20

-  Rain cap
-  Chapeau pare-pluie sur cape de dilatation

 **HINWEIS**



Ausführung mit Vogelschutzgitter /Funkenfluggitter:
bis DN250: LP + 30 €
ab DN300 - DN500: LP + 60 €

Regenhaube mit Windabweiser

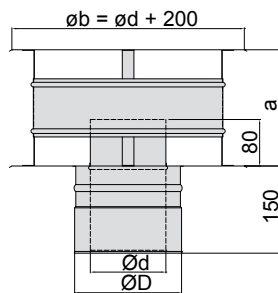
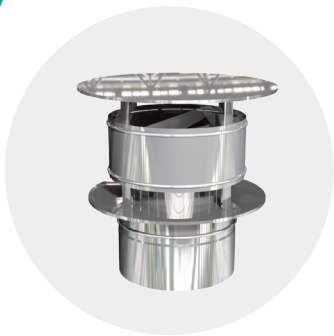
2200-Ø-RHWI



Ø d	Ø D	a	*Lg	€
130	180	200	1,07	141,60
150	200	200	1,18	164,90
160	213	200	1,24	177,80
180	230	200	1,36	190,40
200	250	200	1,48	217,60
250	300	200	1,77	293,60
300	350	200	2,06	412,80



-  Rain cap with wind deflector
-  Chapeau pare-pluie sur cape de dilatation

Abströmkopf

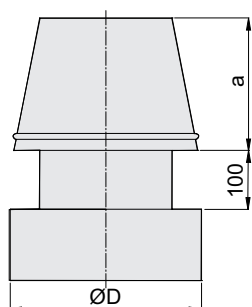
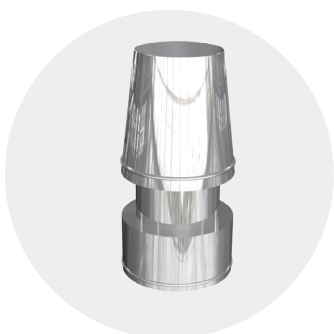
2200-Ø-AK



Ø d	Ø D	a	*Lg	€
130	180	200	1,07	201,80
150	200	210	1,18	212,80
160	213	250	1,24	222,10
180	230	260	1,36	231,60
200	250	290	1,48	249,70
250	300	320	1,77	350,00
300	350	340	2,06	397,60

-  Injector top stub
-  Chapeau d'accélération

*Lg=Legierungsgewicht: Lg (in kg) x Faktor Legierungszuschlag (in €/kg) = Netto-Aufpreis Legierungszuschlag

Dachdurchführung flach Edelstahl

2200-Ø-DF

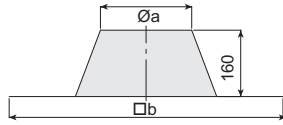
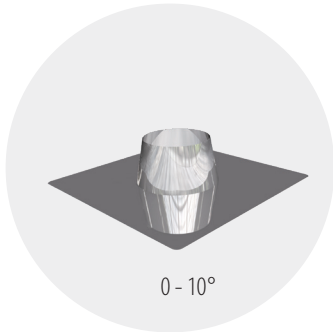

Ø d	Ø a	b x b	*Lg	€
130	240	690	-	60,10
150	240	690	-	60,10
160	240	690	-	60,10
180	290	740	-	67,90
200	290	740	-	67,90
250	340	780	-	90,00
300	390	820	-	111,30

 Flat roof flashing

 Solin de toit plat

 **HINWEIS**

Grundplatte auch aus Blei erhältlich

**Dachdurchführung flach Edelstahl, zylindrisch
400 mm hoch**

2200-Ø-DFZ

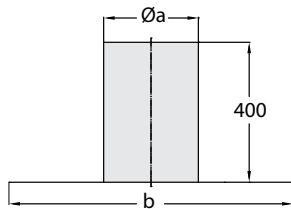
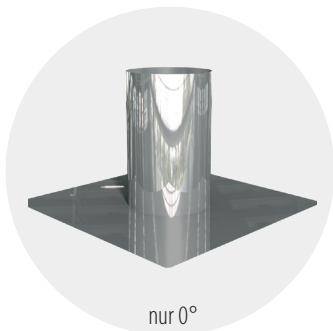

Ø d	Ø a	b x b	*Lg	€
130	260	660	-	99,10
150	260	660	-	99,10
160	260	660	-	99,10
180	310	710	-	110,60
200	310	710	-	110,60
250	360	760	-	143,50
300	410	810	-	174,20

 Flat roof flashing 400 mm, cylindrical

 Solin de toit plat 400 mm

 **HINWEIS**

Grundplatte auch aus Blei erhältlich

Dachdurchführung geneigt 22° mit Blei

2200-Ø-DGB22

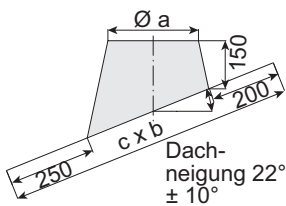
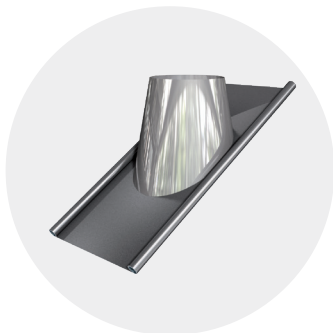

Ø d	Ø a	b	c	*Lg	€
130	243	800	730	-	165,50
150	243	800	730	-	165,50
160	243	800	730	-	165,50
180	290	900	820	-	180,40
200	290	900	820	-	180,40
250	340	900	820	-	201,80
300	390	1000	880	-	217,50

 Adjustable flashing 22°

 Solin de toit incliné 22° en plomb façonnable

 **HINWEIS**

Grundplatte auch aus Edelstahl erhältlich

Aufpreis für zylindrische Ausführung. Bitte genaue Gradzahl angeben!

Dachdurchführung geneigt 32° mit Blei

2200-Ø-DGB32

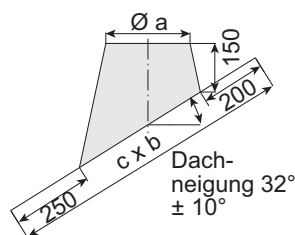
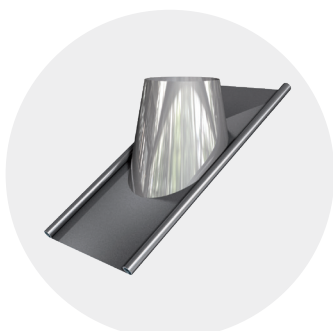

Ø d	Ø a	b	c	*Lg	€
130	243	900	820	-	165,50
150	243	900	820	-	165,50
160	243	900	820	-	165,50
180	290	1000	880	-	180,40
200	290	1000	880	-	180,40
250	340	1000	880	-	203,00
300	390	1140	900	-	217,50

 Adjustable flashing 32°

 Solin de toit incliné 32° en plomb façonnable

 **HINWEIS**

Grundplatte auch aus Edelstahl erhältlich

Aufpreis für zylindrische Ausführung. Bitte genaue Gradzahl angeben!



*Lg=Legierungsgewicht: Lg (in kg) x Faktor Legierungszuschlag (in €/kg) = Netto-Aufpreis Legierungszuschlag

Dachdurchführung geneigt 45° mit Blei

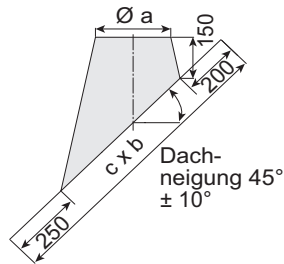
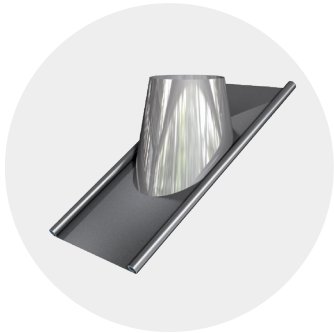
2200-Ø-DGB45



Ø d	Ø a	b	c	*Lg	€
130	243	1000	880	-	199,40
150	243	1000	880	-	199,40
160	243	1000	880	-	199,40
180	290	1140	900	-	227,70
200	290	1140	900	-	227,70
250	340	1140	900	-	263,10
300	390	1200	930	-	278,80

-  Adjustable flashing 45°
-  Solin de toit incliné 45° en plomb façonnable

HINWEIS

Grundplatte auch aus Edelstahl erhältlich



Aufpreis für zylindrische Ausführung. Bitte genaue Gradzahl angeben!

Dachdurchführung First mit Blei

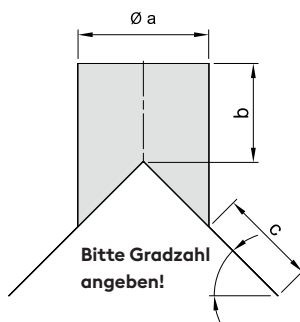
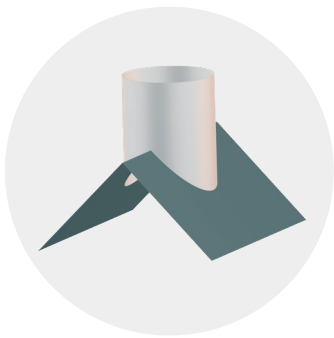
2200-Ø-DGBF



Ø d	Ø a	b	c	*Lg	€
130	243	200	200	-	299,10
150	243	200	200	-	299,10
160	243	200	200	-	299,10
180	290	200	200	-	341,60
200	290	200	200	-	341,60
250	340	200	200	-	394,65
300	390	200	200	-	418,20

-  Roof duct at the ridge
-  Passage de toit au faite

HINWEIS



Bis 50° Dachneigung möglich

Regenkragen

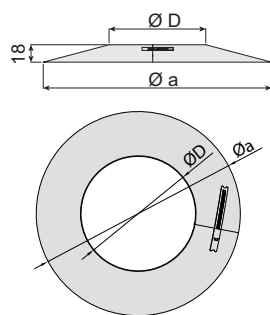
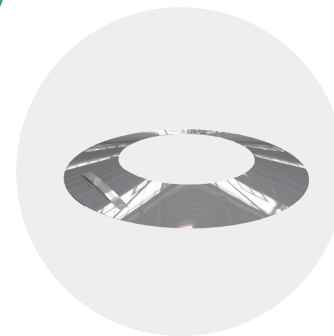
2200-Ø-RK



Ø d	Ø D	Ø a	*Lg	€
130	180	336	-	26,10
150	200	356	-	27,90
160	213	369	-	27,90
180	230	386	-	29,30
200	250	406	-	31,00
250	300	456	-	36,50
300	350	506	-	37,90



-  Rain/storm collar
-  Colletette de pluie

Regenkragen 45°

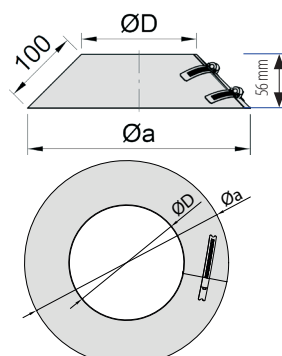
2200-Ø-RK45



Ø d	Ø D	Ø a	*Lg	€
130	180	321	-	39,20
150	200	341	-	41,80
160	213	354	-	41,80
180	230	371	-	43,80
200	250	391	-	46,40
250	300	441	-	54,70
300	350	491	-	56,80

-  Rain/storm collar 45°
-  Colletette de pluie 45°

*Lg=Legierungsgewicht: Lg (in kg) x Faktor Legierungszuschlag (in €/kg) = Netto-Aufpreis Legierungszuschlag



Regenkragen mit Dichtung

2200-Ø-RKED

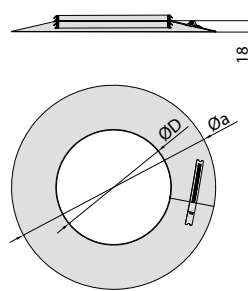
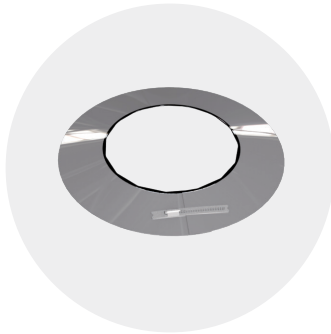

Ø d	Ø D	Ø a	*Lg	€
130	180	336	-	37,90
150	200	356	-	40,60
160	213	369	-	40,60
180	230	386	-	45,00
200	250	406	-	46,70
250	300	456	-	55,00
300	350	506	-	59,80



-  Rain/storm collar with sealant
-  Colerette de pluie avec joint

Regenkragen 45° mit Dichtung

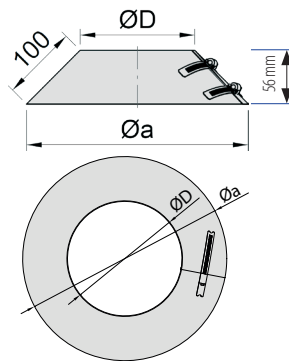
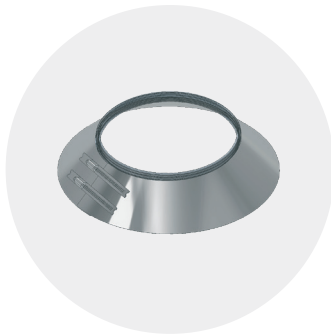
2200-Ø-RKED45



Ø d	Ø D	Ø a	*Lg	€
130	180	326	-	51,00
150	200	346	-	54,60
160	213	359	-	54,60
180	230	376	-	57,90
200	250	396	-	62,10
250	300	446	-	73,20
300	350	496	-	78,60



-  Rain/storm collar 45° with sealant
-  Colerette de pluie 45°

Zweiteilige Blende

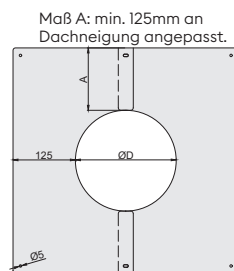
2200-Ø-BL



ØD	BL 0° €	BL 45° €	BL 60° €
130	47,70	63,50	70,60
150	47,70	63,50	70,60
160	47,70	63,50	70,60
180	47,70	63,50	70,60
200	47,70	63,50	70,60
250	47,70	63,50	70,60
300	55,30	73,00	82,80

-  Two-piece faceplate
-  Plaque pare-feu, demi-ronde, prière de préciser la pente en degrés de votre toiture

 **HINWEIS**

Gradzahl entsprechend der Dachneigung angeben!



Sondergrößen: Preis auf Anfrage.
Maß A: min. 125mm an Dachneigung angepasst.

Zweiteilige Blende mit Hinterlüftung

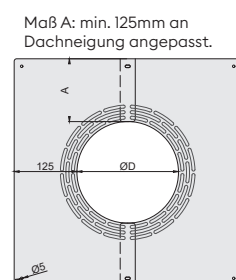
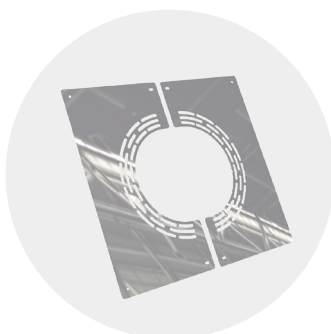
2200-Ø-BLH



ØD	BLH 0° €	BLH 45° €	BLH 60° €
130	66,60	90,30	100,90
150	66,60	90,30	100,90
160	66,60	90,30	100,90
180	66,60	90,30	100,90
200	66,60	90,30	100,90
250	66,60	90,30	100,90
300	77,90	106,50	119,00

-  Two-piece faceplate with ventilation
-  Plaque pare-feu, demi-ronde, prière de préciser la pente en degrés de votre toiture

 **HINWEIS**

Gradzahl entsprechend der Dachneigung angeben!

Sondergrößen: Preis auf Anfrage.
Maß A: min. 125mm an Dachneigung angepasst.

*Lg=Legierungsgewicht: Lg (in kg) x Faktor Legierungszuschlag (in €/kg) = Netto-Aufpreis Legierungszuschlag

Zweiteilige Blende, rund

2200-Ø-BL-RU

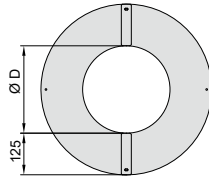
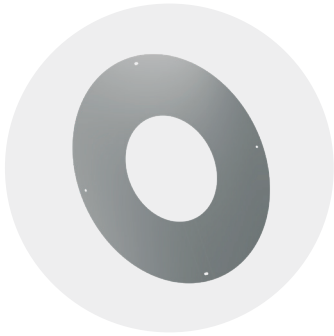

ØD	BL-RU 0° €	BL-RU 45° €	BL-RU 60° €
130	47,70	63,50	70,60
150	47,70	63,50	70,60
160	47,70	63,50	70,60
180	47,70	63,50	70,60
200	47,70	63,50	70,60
250	47,70	63,50	70,60
300	55,30	73,00	82,80

- Two-piece faceplate, round. Specify the number of degrees according to the roof pitch!
- Plaque pare-feu, demi-ronde, prière de préciser la pente en degrés de votre toiture

HINWEIS

Gradzahl entsprechend der Dachneigung angeben!

Zweiteilige Blende mit Hinterlüftung, rund

2200-Ø-BLH-RU

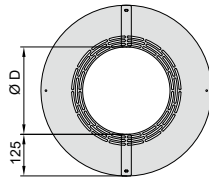
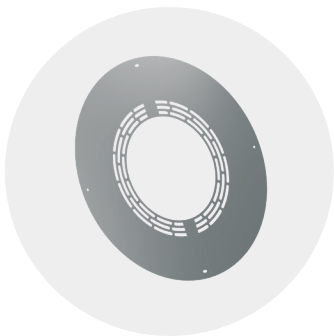

ØD	BLH-RU 0° €	BLH-RU 45° €	BLH-RU 60° €
130	66,60	90,30	100,90
150	66,60	90,30	100,90
160	66,60	90,30	100,90
180	66,60	90,30	100,90
200	66,60	90,30	100,90
250	66,60	90,30	100,90
300	77,90	106,50	119,00

- Two-piece faceplate round, with ventilation. Specify the number of degrees according to the roof pitch!
- Plaque pare-feu, demi-ronde, prière de préciser la pente en degrés de votre toiture

HINWEIS

Gradzahl entsprechend der Dachneigung angeben!

Zweiteilige Blende, einstellbar

2200-Ø-BLxx-xx

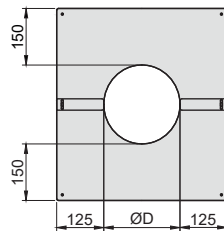
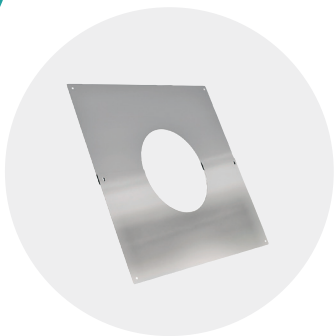

ØD	BL 0 - 15° €	BL 15 - 30° €	BL 30 - 45° €
130	50,10	52,60	55,30
150	50,10	52,60	55,30
160	50,10	52,60	55,30
180	50,10	52,60	55,30
200	50,10	52,60	55,30
250	50,10	52,60	55,30
300	58,00	60,90	64,00

- Two-piece faceplate
- Plaque pare-feu, demi-ronde, prière de préciser la pente en degrés de votre toiture

Zweiteilige Blende mit Hinterlüftung, einstellbar

2200-Ø-BLHxx-xx

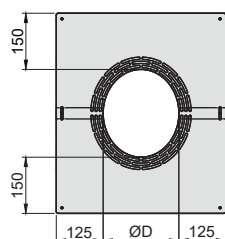
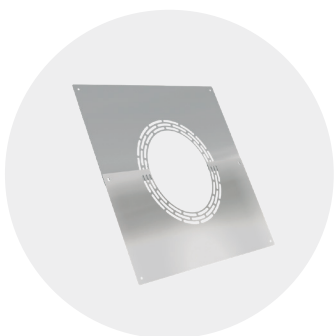

ØD	BLH 0 - 15° €	BLH 15 - 30° €	BLH 30 - 45° €
130	69,90	73,40	77,10
150	69,90	73,40	77,10
160	69,90	73,40	77,10
180	69,90	73,40	77,10
200	69,90	73,40	77,10
250	69,90	73,40	77,10
300	81,80	86,00	90,20

- Two-piece faceplate with ventilation
- Plaque pare-feu, demi-ronde, prière de préciser la pente en degrés de votre toiture

*Lg=Legierungsgewicht: Lg (in kg) x Faktor Legierungszuschlag (in €/kg) = Netto-Aufpreis Legierungszuschlag



ZUBEHÖRTEILE FÜR SYSTEM eka COMPLEX COSMOS D

Einzeldichtung max. 200°C

1000-Ø-ED

für Erdgas-Anlagen max. 200°C

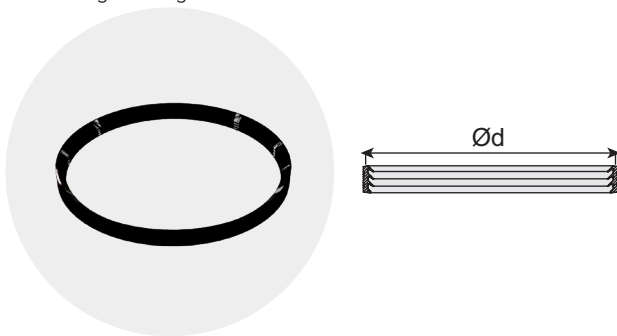

Ø d	*Lg	€
130	-	9,40
150	-	10,80
160	-	10,90
180	-	12,60
200	-	13,60
250	-	16,70
300	-	19,80



Gasket, max. 200°C,
natural gas



Joint pour manchon, à triple
lèvre, max. 200°C, gas naturel



HINWEIS

Gleitmittel 1000-000-GM
verwenden!

Einzeldichtung Viton, max. 200°C

1000-Ø-EDVIT

für Öl-Brennwert-Anlagen max. 200°C, BHKW-Anlagen

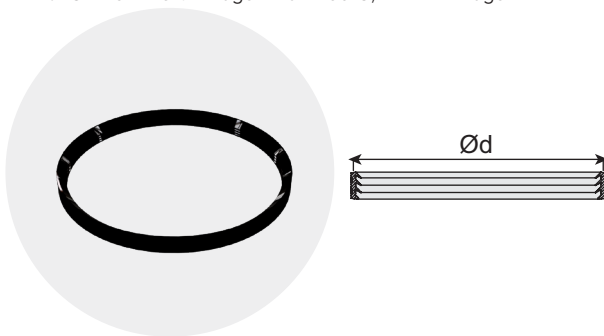

Ø d	*Lg	€
130	-	38,00
150	-	41,90
160	-	44,10
180	-	49,10
200	-	53,00
250	-	64,20
300	-	75,30



Viton Gasket, max. 200°C



Joint pour manchon, à triple
lèvre, max. 200°C,



HINWEIS

Gleitmittel 1000-000-GM
verwenden!

Gleitmittel

1000-000-GM



ml	€
100	5,50



Silicon grease



Agent lubrifiant pour
montage



HINWEIS

Für ED und EDVIT verwenden

*Lg=Legierungsgewicht: Lg (in kg) x Faktor Legierungszuschlag (in €/kg) = Netto-Aufpreis Legierungszuschlag

Teleskopstange verstellbar bis 2,9 m (2 Stück)

1000-000-TS1 / TS3

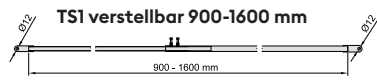
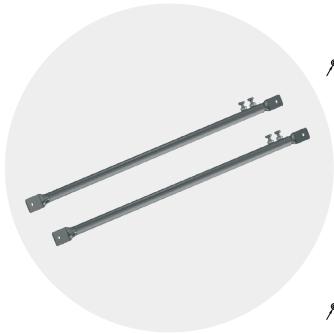

Typ		€
TS1	-	235,50
TS3	-	365,80

 Adjustable telescopic rod for lengths up to 1,6 / 2,9 m
2 pcs.

 Barre télescopique réglable fino a 1,6 / 2,9 m
2 pièces

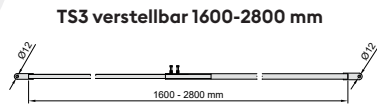

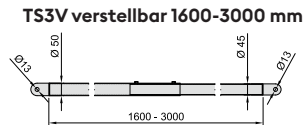

Teleskopstange verstellbar, verstärkte Ausführung (2 Stück)

1000-000-TS3V



Typ		€
TS3V	-	507,40

 Reinforced adjustable telescopic rod for lengths up to 3 m
2 pcs.

 Renforcé barre télescopique réglable fino a 3 m
2 pièces

Ankerplatte (2 Stück)

1000-000-ANKER

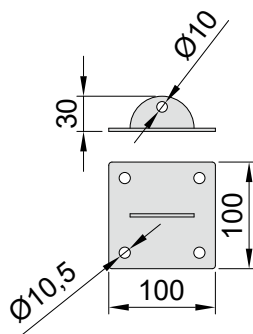
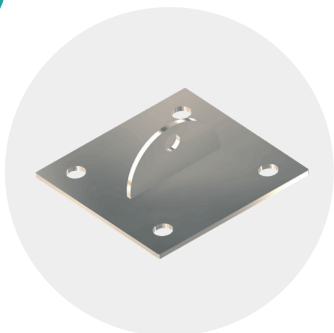

	*Lg	€
	-	60,00

 Anchor plate, 2 pcs.

 Plaque d'ancrage
2 pièces

Dachhaken für Teleskopstange (2Stück)

1000-000-DA / DAD

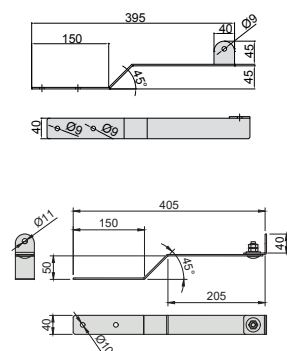
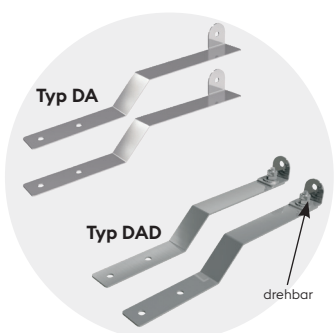

Typ		€
DA	-	89,70
DAD	-	103,20

 Roof hook, 2 pcs.

 Crochet de couvreur
2 pièces

*Lg=Legierungsgewicht: Lg (in kg) x Faktor Legierungszuschlag (in €/kg) = Netto-Aufpreis Legierungszuschlag

Dachschiene für Rohrverlegung auf Dach

1000-000-DS

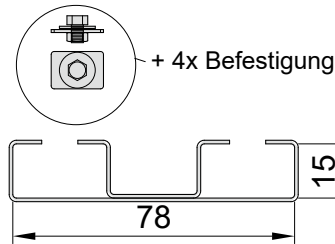
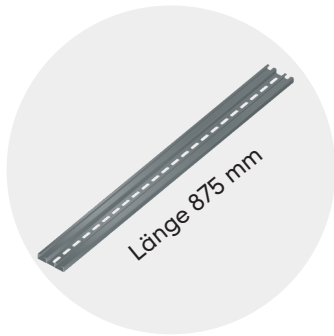

*Lg	€
-	105,00

 Roof rail for installing pipes on the roof

 Rail pour la pose de tuyaux sur le toit

 **HINWEIS**

andere Längen auf Anfrage

Dachhaken für Dachschiene (2 Stück)

1000-000-DHDS

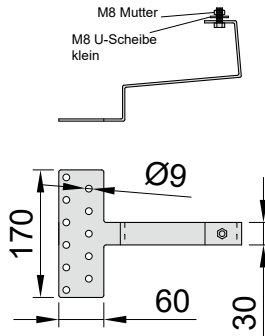

*Lg	€
-	75,00

 Roof hook for roof rail, 2 pcs.

 Crochet pour rail de toit 2 pièces

Dachhaken verstellbar für Dachschiene (2 Stück)

1000-000-DHVDs

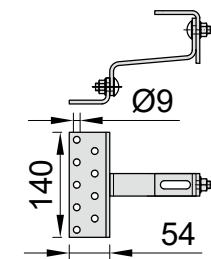
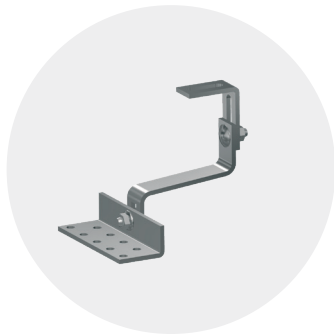

*Lg	€
-	75,00

 Roof hook for roof rail 2 pcs.

 Crochet pour rail de toit 2 pièces

Kragarm

1000-Ø-KRAG

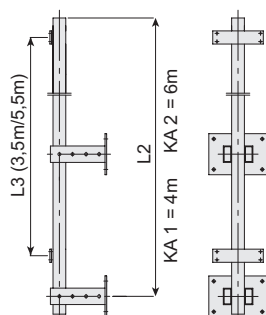

Ausführung verzinkt oder in Edelstahl.

Preise auf Anfrage.

 Long arm support

 Mat de fixation déporté



*Lg=Legierungsgewicht: Lg (in kg) x Faktor Legierungszuschlag (in €/kg) = Netto-Aufpreis Legierungszuschlag

Dachdurchführung geneigt 22° Elastomere
(Elastomere = Bleiersatz-Material)

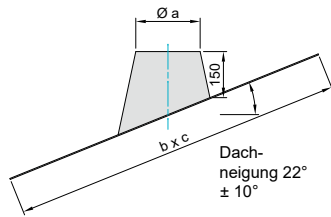
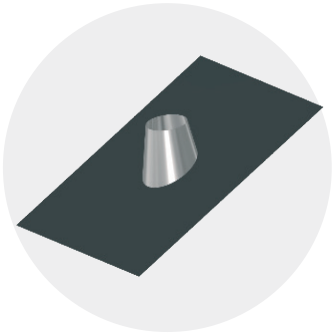
2250-Ø-DGELB22-X



Ø d	Ø a	b	c	€
130	243	1000	1200	407,10
150	243	1000	1200	407,10
160	243	1000	1200	407,10

-  Adjustable flashing 22°
-  Solin de toit incliné 22°

HINWEIS

S = Schwarz
T = Terrakotta



Weitere Größen auf Anfrage

Dachdurchführung geneigt 32° Elastomere
(Elastomere = Bleiersatz-Material)

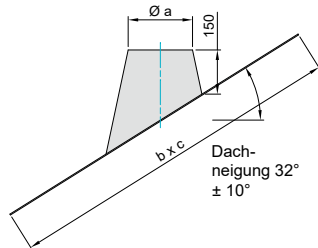
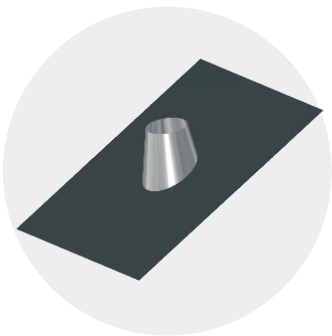
2250-Ø-DGELB32-X



Ø d	Ø a	b	c	€
130	243	1000	1200	433,70
150	243	1000	1200	433,70
160	243	1000	1200	433,70

-  Adjustable flashing 32°
-  Solin de toit incliné 32°

HINWEIS

S = Schwarz
T = Terrakotta



Weitere Größen auf Anfrage

Dachdurchführung geneigt 45° Elastomere
(Elastomere = Bleiersatz-Material)

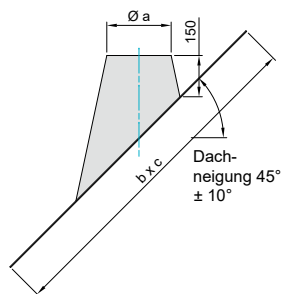
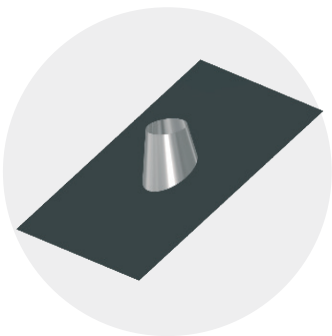
2250-Ø-DGELB45-X



Ø d	Ø a	b	c	€
130	243	1000	1200	470,90
150	243	1000	1200	470,90
160	243	1000	1200	470,90

-  Adjustable flashing 45°
-  Solin de toit incliné 45°

HINWEIS

S = Schwarz
T = Terrakotta

Weitere Größen auf Anfrage

Dachdurchführung für Trapezblech (RM) oder für Faserzementwelldach (RMF)

2250-RM / RMF

für Dachneigung 0 - 45°

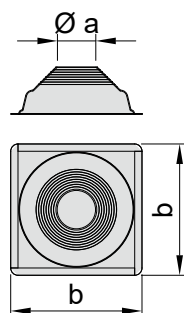
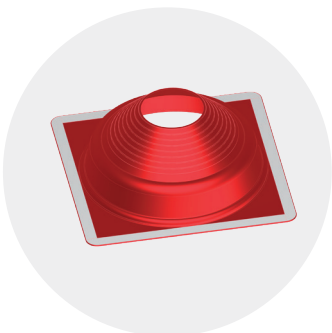



Ø d	Ø a	b x b	€
100 - 250	150 - 300	456x456	711,50

Set RM bestehend aus:
1 Rohrmanschette
1 Kartusche Fugendichtstoff
1 Bohrschraubenset

Ø d	Ø a	b x b	€
100 - 250	150 - 300	456x456	711,50

Set RMF bestehend aus:
1 Rohrmanschette
1 Kartusche Fugendichtstoff
1 Blindnietenset

-  Roof duct for trapezoidal sheet metal (RM) or for corrugated fibre cement roofs (RMF)

-  Passage de toit pour tôle trapézoïdale (RM) ou pour toit ondulé en fibrociment (RMF)

*Lg=Legierungsgewicht: Lg (in kg) x Faktor Legierungszuschlag (in €/kg) = Netto-Aufpreis Legierungszuschlag



HotSchott - Abdichtung von Dachdurchdringungen bis 45° Dachneigung

Anwendungsbereich für doppelwandige Edelstahl-Abgasanlagen:

- Einsatz bei Dampfsperren und Unterspannbahnen
- Einsatz von Decken- und Dachdurchführungen
- Einsatz zum Blower-Door-Test
- Einsatz bis Temperaturklasse T600
- Einsatz bei Wanddurchführungen



- ✓ Die hochelastischen EPDM-Manschetten sind mit einem Klebekragen versehen.
- ✓ Sie besitzen eine extrem starke Klebekraft und sind reißfest.
- ✓ Sie bestehen aus einer flexiblen Gummidurchführung verbunden mit einem selbstklebenden Pad mit einer alterungsbeständigen Kleber-Schicht.
- ✓ Bei sandigen oder saugenden Oberflächen ist als Voranstrich für die Verklebung immer der Haftprimer zu verwenden! (z.B. eka Decken- und Dachdurchführungen)
- ✓ Temperaturbeständigkeit: bis zu 250 °C Oberflächentemperatur
- ✓ TÜV-geprüft
- ✓ Senkung der Wärmeverluste

Der bauseitige Brandschutz ist zu beachten!

Dichtungsmanschette HOTSchott **2250ØHOT / HOT45**

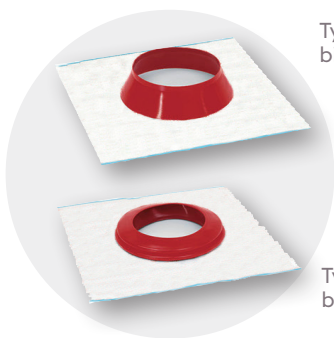

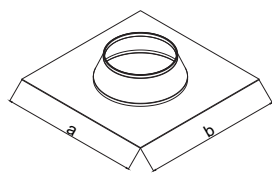

Typ HOT
bis 30° Dachneigung



Typ HOT45
bis 45° Dachneigung



Ø d	HOT		HOT45	
	a x b	a x b	€	€
100	350 x 350	350 x 350	138,30	182,60
113	350 x 350	350 x 350	138,30	182,60
130	400 x 400	400 x 400	142,40	189,10
150	420 x 420	400 x 400	157,10	195,50
160	420 x 420	400 x 400	157,10	195,50
180	580 x 580	580 x 580	164,40	217,60
200	580 x 580	580 x 580	180,40	231,00
250	-	580 x 580	-	253,70

-  Sealing collar, self-adhesive
-  Manchette d'étanchéité, autocollante

Haftprimer **1990 000 HPxxx**



Technische Daten	Preis
	€
1990 000 HP 000	125 ml 20,90
1990 000 HP 001	250 ml 39,40
1990 000 HP 002	500 ml 52,40

-  Adhesive primer
-  Primer d'adhérence

 **HINWEIS**
(Rabattgruppe eka compact)

*Lg=Legierungsgewicht: Lg (in kg) x Faktor Legierungszuschlag (in €/kg) = Netto-Aufpreis Legierungszuschlag

MAXIMALE STATISCHE MONTAGEHÖHE UND ABSTÄNDE

Maximale statische Montagehöhe und Abstände

Nennweite/mm	a/m	b/m	c/m	d/m	e/m	f/m
130	30	29	29	4	30	3
150	30	29	29	4	30	3
160	30	29	29	4	30	3
180	30	28	28	4	30	3
200	30	26	26	4	30	3
250	28	23	23	4	28	3
300	23	20	20	4	23	3

- a: maximale Aufbauhöhe über Konsole
- b: maximale Aufbauhöhe über Reinigungsöffnung
- c: maximale Aufbauhöhe über Feuerungsanschluß
- d: maximaler Abstand zwischen zwei Wandhaltern
- e: maximale Aufbauhöhe über Längenelementen
- f: maximale freie Auskragung

MAXIMUM STATIC HEIGHT AND DISTANCES

- a: max. height above support
- b: max. height above inspection element
- c: max. height above T-element (firing connection)
- d: max. distance between two wall bands
- e: max. height above length elements
- f: max. freestanding without support

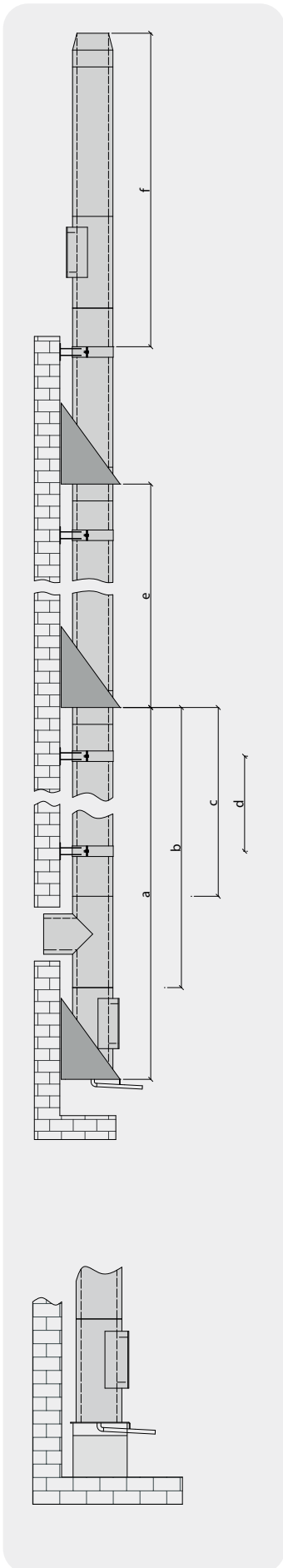

VERSATZMASSE BEI SCHRÄGFÜHRUNG AXIAL DISTANCE WHEN USING ELBOWS

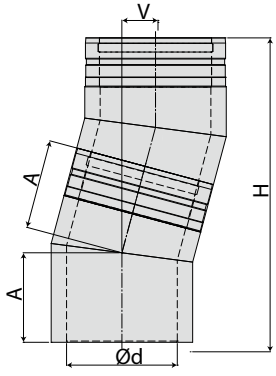
Bogenversatz 15° axial distance when using elbow 15°	25 mm Isolierung/ isolation			
	Ø mm	A mm	H mm	V mm
	130	142	481	53
	150	143	487	54
	160	144	489	54
	180	145	494	55
	200	146	500	55
	250	150	512	57
	300	153	525	59
	mit /with L3	+270	+ 72 mm	
	mit /with L5	+442	+118 mm	
	mit /with L10	+964	+258 mm	

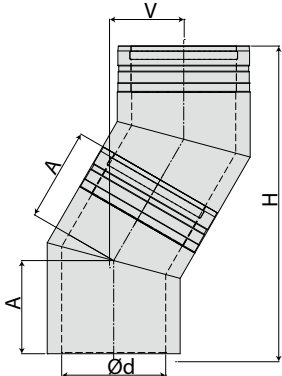
Bogenversatz 30° axial distance when using elbow 30°	25 mm Isolierung/ isolation			
	Ø mm	A mm	H mm	V mm
	130	154	507	115
	150	157	517	117
	160	158	522	119
	180	161	532	121
	200	163	542	124
	250	170	567	131
	300	177	592	137
	mit /with L3	+240	+140 mm	
	mit /with L5	+395	+230 mm	
	mit /with L10	+864	+500 mm	

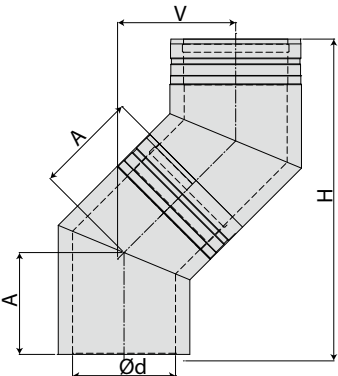
Bogenversatz 45° axial distance when using elbow 45°	25 mm Isolierung/ isolation			
	Ø mm	A mm	H mm	V mm
	130	167	515	181
	150	171	529	187
	160	173	536	189
	180	178	551	195
	200	182	565	201
	250	192	600	216
	300	202	635	230
	mit /with L3	+188	+188 mm	
	mit /with L5	+324	+324 mm	
	mit /with L10	+697	+697mm	

AUSSENWANDTEMPERATUREN

Edelstahlschornsteine mit 25 mm Isolierung
Außenwandtemperaturen bei verschiedenen Kerntemperaturen

Nachstehende Temperaturangaben sind Ergebnisse von Ausbrenn-Prüfungen an dreischaligen
Edelstahlschornsteinen, die von unabhängigen Prüfstellen in Deutschland durchgeführt wurden.

Kerntemperatur 350 °C

Einwirkzeit (min)	5	30	60	90	120
Temperatur an der Außenschale (°C) bei 25 mm Dämmung ISO	25	80	82	83	83

Kerntemperatur 500 °C

Einwirkzeit (min)	5	30	60	90	120
Temperatur an der Außenschale (°C) bei 25 mm Dämmung ISO	21	117	120	121	125

Kerntemperatur 1000 °C

Einwirkzeit (min)	6	10	15	20	30
Temperatur an der Außenschale (°C) bei 25mm Dämmung ISO	30	118	300	341	319

SCHORNSTEINSYSTEME AUS EDELSTAHL: EKA SYSTEM COMPLEX COSMOS D TABELLE DER DÜBELANSCHLUSSKRÄFTE IN KN

Querschnitt Innenrohr	Konsolen			Wandhalter			Kragarm- länge
	Wandabstand			Wandabstand			
(/)	50	200	400	50	200	400	
mm	mm	mm	mm	mm	mm	mm	m
130	0,56	0,96	1,53	0,40	0,72	1,15	3,00
150	0,66	1,06	1,63	0,42	0,72	1,15	3,00
160	0,72	1,13	1,73	0,44	0,73	1,16	3,00
180	0,78	1,20	1,82	0,45	0,74	1,16	3,00
200	0,81	1,23	1,83	0,46	0,76	1,16	3,00
250	0,88	1,26	1,82	0,52	0,80	1,19	3,00
300	0,83	1,16	1,83	0,57	0,84	1,22	3,00
Dübelanzahl je Halterungsarm	4	4	4	4	4	4	4

HINWEIS

- Bei den Dübelanschlusßkräften der Tabelle handelt es sich um Schrägzugkräfte je Befestigungsdübel (1kN entspricht 100 kg)
- Der Wandabstand des Schornsteinzuges darf maximal 40 cm betragen.
(Größere Wandabstände nach Anfrage)
- Die Dübelkräfte für die Wandhalter gelten bei Höhen über Gelände bis zu 20 m.
Für Schornsteinhöhe über Gelände bis zu 8 m gilt ein Abminderungsfaktor von 0,63.
Für Schornsteinhöhe über Gelände zwischen 20 m und 100 m gilt ein Vergrößerungsfaktor von 1,38.

COMPARISON TABLE EXTERIOR TEMPERATURES

Stainless steel chimney with 25 mm isolation
Temperatures at different interior core temperatures

The following temperatures resulted from burning tests with double wall chimneys, that were proofed in germany by independent testing institutions.

core temperature 350 °C					
time (min)	5	30	60	90	120
temperature at exterior pipe (°C) 25 mm isolation ISO	25	80	82	83	83

core temperature 500 °C					
time (min)	5	30	60	90	120
temperature at exterior pipe (°C) 25 mm isolation ISO	21	117	120	121	125

core temperature 1000 °C					
time (min)	6	10	15	20	30
temperature at exterior pipe (°C) 25 mm isolation ISO	30	118	300	341	319

CHIMNEY SYSTEMS MADE OF STAINLESS STEEL: SYSTEM COMPLEX COSMOS D TABLE FOR DOWEL TENSILE STRENGTH KN

Cross section interior pipe	Consoles			wall band			freestanding without support
	Wall distance			Wall distance			
(/)	50	200	400	50	200	400	
mm	mm	mm	mm	mm	mm	mm	m
130	0,56	0,96	1,53	0,40	0,72	1,15	3,00
150	0,66	1,06	1,63	0,42	0,72	1,15	3,00
160	0,72	1,13	1,73	0,44	0,73	1,16	3,00
180	0,78	1,20	1,82	0,45	0,74	1,16	3,00
200	0,81	1,23	1,83	0,46	0,76	1,16	3,00
250	0,88	1,26	1,82	0,52	0,80	1,19	3,00
300	0,83	1,16	1,83	0,57	0,84	1,22	3,00
Number of pegs for each mounting support	4	4	4	4	4	4	4

⚠ IMPORTANT NOTE:

1. Dowel tensile strengths given in the table are oblique application of pull are given per dowel (1kN corresponds 100 kg)
2. Maximum distance between wall and chimney may be up to 40 centimetres.
(longer distance are available by request.)
3. The dowel tensile strengths for wall bands are valid for height up to 20 m above surface level.
For chimneys with a height of up to 8,00 m use a factor of 0,63 to calculate tensile strengths.
For chimneys with a height between 20,00 m and 100,00 m use a factor of 1,38 to calculate tensile strengths

ANORDNUNG STATISCHER BAUTEILE

VARIANTE 1

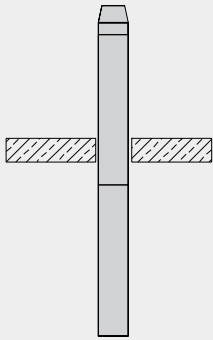

Statische Bauteile:
nicht erforderlich

maximale freie Auskragung:
1 m

VARIANTE 2

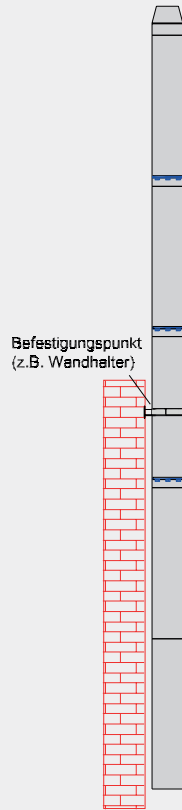

Statische Bauteile:
erforderlich

maximale freie Auskragung:
3 m

VARIANTE 3

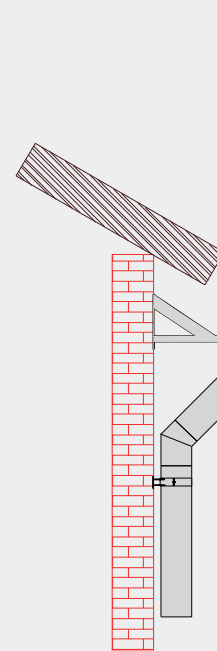

BPZST
Statische Bauteile:
erforderlich

maximale freie Auskragung:
1,5 m mit BPZST
3 m BPZST verschweißt
mit LIOST oder PHST/PNST

AUFPREISE

- | | | |
|---|-----|---------------------|
| • für Innenwanddicke 1,0 mm anstatt 0,6 mm | 15% | (rabattfähig) |
| • Außenschale in Edelstahl, Material 1.4301 (AISI 304), matt | | (ohne Aufpreis) |
| • Außenschale in Edelstahl, Material 1.4301 (AISI 304), gebürstet | 10% | (rabattfähig) |
| • Außenschale in Edelstahl, Material 1.4404 (AISI 316L), matt | 15% | (rabattfähig) |
| • für alle pulverbeschichteten Teile (min. 120,00 € Netto) | 30% | (nicht rabattfähig) |
| • für galvanisches Verkupfern der Aussenschale (min. 80,00 € Netto) | 35% | (nicht rabattfähig) |

ADDITIONAL PRICE FOR...

- | | | |
|--|-----|------------------------|
| • for inner wall thickness 1.0 mm instead of 0.6 mm | 15% | |
| • Outer skin 1.4304 (AISI 304), matte surface | | (without extra charge) |
| • Outer skin 1.4304 (AISI 304), brushed surface | 10% | |
| • Outer skin 1.4404 (AISI 316L), matte surface | 15% | |
| • Outer surface color (powder - coating) (min. 120,00 € net price) | 30% | (net price) |
| • Copper outer skin (galvanic coating) (min. 80,00 € net price) | 35% | (net price) |

HINWEISE FÜR SPEZIELLE AUSFÜHRUNGEN:

- Beim Betrieb von Heizkesseln ist sicherzustellen, daß keine FCKW-haltigen Bestandteile in die Verbrennungsluft gelangen können. Siehe hierzu auch das BDH-Informationsblatt Nr. 1 „Korrosion durch Halogenkohlenwasserstoffe“. (www.bdh-industrie.de/service/infoblaetter)
- Bei der Errichtung von Edelstahl-Abgasanlagen im Küstengebiet (bis ca. 50 km von der Küste) kann die Außenschale durch salzhaltige Meeresluft optisch beeinträchtigt werden. Es ist daher eine Ausführung mit Pulverbeschichtung (RAL-Farbe) empfehlenswert.



SONSTIGE HINWEISE:

Bauteile für Wanddurchführungen finden Sie im eka-Katalog unter „Wand-, Decken- und Dachdurchführungen“.

HINWEISE ZUR PFLEGE:

Wir empfehlen in vierteljährlichen Abständen die Pflege des Edelstahlprodukts (z.B. Abwaschen mit klarem Wasser). Diese dient der optischen und hygienischen Oberflächenbehandlung zur Werterhaltung.

Wichtig ist dies vor allem in Küstennähe und Industrieumgebungen bzw. überall dort, wo es zu Aufkonzentration von Chloriden und Schwefeldioxid kommen kann.

Technische Änderungen vorbehalten.

Alles Wissenswerte für Sie...

- Zertifizierung nach EN1856-1
- Leistungserklärung 001 DOP 90216 2013
- Preisliste je Stück in EUR zzgl. ges. MwSt.
- Es gelten unsere Liefer- und Zahlungsbedingungen
- Alle Angebote sind freibleibend
- Kurzfristige Lieferzeiten
- Größere Durchmesser und Sonderanfertigungen nach Rücksprache
- Querschnittsberechnungen auf Anfrage
- Muffentiefe 80 mm
- Technische Änderungen behalten wir uns vor
- Technische Informationen/Bemaßung siehe Teileübersicht
- Aufpreis für andere Materialstärken, farbige Ausführungen oder Ausführung galvanisch verkupfert
- Generell wird in der Währung EUR faktorisiert.

Unser weiteres Lieferprogramm

- Einwandiges Schornsteinsystem mit Wanddicke 0,6 mm
- Einwandiges Schornsteinsystem mit Wanddicke 1,0 mm
- Flexibles Edelstahl-System doppelagig (innen glatt) und einlagig
- L90-Leichtbau-Schachtsystem
- Kunststoff-Abgassystem
- Kaminabdeckungen aus Edelstahl und Edelstahl verkupfert
- Hosenstücke
- Luft-Abgas-System
- freistehende Anlagen

* wird in diese Bauteile eine (**zwei) Einzeldichtung eingebaut, sind sie zum Anschluß an Brennwert- Feuerstätten geeignet (Preis zzgl. ED).

LZ: Legierungszuschlag: $L_g \text{ (kg)} \times \text{Faktor Legierungszuschlag (€/kg)} =$
Netto-Aufpreis Legierungszuschlag.

All what you have to know...

- certification (EN1856-1)
- declaration of performance 001 DOP 90216 2013
- price list per piece in EUR plus VAT
- our general payment and delivery terms are valid
- all offers are without engagement
- short delivery
- specials on request
- calculation of bigger sizes or specials on request
- length of coupler 80 mm
- we reserve us the right to change technical details
- technical information and dimensions look technical brochure
- additional price for further wall thickness, color coatings or galvanized copper surface

Our further product range

- single wall system 0,6 mm
- single wall system 1,0 mm
- flexible liners-double and single wall
- L90 light-weight enclosure
- plastic flue liner
- chimney roof out of stainless steel or copper-plated
- connection with ypsilon diverter
- LAS combustion air/fluegas
- free standing chimneys

eka-edelstahlkamine GmbH
Robert-Bosch-Straße 4
D-95369 Untersteinach
tel.: (+49) 9225 981-01
fax: (+49) 9225 981-11
info@eka-edelstahlkamine.de

eka-edelstahlkamine.de



sphering-group.com



Flue & Air Care
Since 1919